

77 ILLINOIS ADMINISTRATIVE CODE 905  
OCTOBER 2013

TITLE 77: PUBLIC HEALTH  
CHAPTER I: DEPARTMENT OF PUBLIC HEALTH  
SUBCHAPTER r: WATER AND SEWAGE

PART 905  
PRIVATE SEWAGE DISPOSAL CODE

Section	
905.10	Definitions
905.15	Incorporated and Referenced Materials
905.20	General Requirements
905.30	Approved Private Sewage Disposal Systems
905.40	Septic Tanks
905.50	Distribution Boxes
905.55	Subsurface Seepage System Design Requirements
905.60	Subsurface Seepage System Construction Requirements
905.70	Buried Sand Filters
905.80	Re-circulating Sand Filter
905.90	Waste Stabilization Ponds
905.95	Illinois Raised Filter Bed
905.96	Peat Filter Systems
905.100	Aerobic Treatment Plants and NSF International/ANSI Standard 40 Wastewater Treatment Systems
905.110	Effluent Discharges
905.115	NPDES Permit Compliance
905.120	Disinfection
905.125	Pumps, Pumping/Dosing Chambers, and Ancillary Equipment
905.130	Human Waste Disposal
905.135	Portable Sanitation
905.140	Holding Tanks
905.150	Sanitary Dump Stations
905.160	Swimming Pool Wastewater
905.170	Servicing, Cleaning, Transporting and Disposing of Wastes from Private Sewage Disposal Systems
905.180	Examinations for Licensure
905.190	Installation Approval
905.200	Licenses and Fees
905.205	Civil Penalties and Time Allowances for Corrective Action
905.210	Notification of Disposal Site (Repealed)
905.APPENDIX A	Illustrations and Exhibits
905.ILLUSTRATION A	Quantity of Sewage Flows
905.ILLUSTRATION B	Approved Plastic Pipe Materials (Repealed)
905.ILLUSTRATION C	List of Approved Plastic Pipe for Private Sewage Disposal System
905.ILLUSTRATION D	Location of Components of Private Sewage Disposal Systems

77 ILLINOIS ADMINISTRATIVE CODE 905  
OCTOBER 2013

905.ILLUSTRATION E	Septic Tanks
905.EXHIBIT A	Septic Tank with Slip-In Baffles
905.EXHIBIT B	Septic Tank with T-Baffles
905.EXHIBIT C	Typical Gas Deflection Devices
905.ILLUSTRATION F	Minimum Volumes for Septic Tanks Serving Residential Units
905.ILLUSTRATION G	Instructions for Conducting Percolation Tests
905.ILLUSTRATION H	Subsurface Seepage System Size Determination
905.EXHIBIT A	Gravel System
905.EXHIBIT B	Gravelless System
905.ILLUSTRATION I	Seepage Field Construction
905.EXHIBIT A	Gravel System
905.EXHIBIT B	Size and Spacing – Gravel System
905.EXHIBIT C	Gravelless and Chamber System
905.EXHIBIT D	Spacing – Gravelless and Chamber Systems
905.EXHIBIT E	Chamber Sizing Requirements
905.ILLUSTRATION J	Septic Tank Subsurface Seepage Field
905.EXHIBIT A	Plan View – Gravel System
905.EXHIBIT B	Section View – Gravel System
905.EXHIBIT C	Plan View – Gravelless and Chamber System
905.EXHIBIT D	Section View – Gravelless and Chamber System
905.ILLUSTRATION K	Serial Distribution
905.EXHIBIT A	Plan View #1 – Gravel System
905.EXHIBIT B	Section View #1 – Gravel System
905.EXHIBIT C	Plan View #2 – Gravel System
905.EXHIBIT D	Section View #2 – Gravel System
905.EXHIBIT E	Plan View #1 – Gravelless System
905.EXHIBIT F	Section View #1 – Gravelless System
905.EXHIBIT G	Plan View #2 – Gravelless System
905.EXHIBIT H	Section View #2 – Gravelless System
905.ILLUSTRATION L	Seepage Bed
905.EXHIBIT A	Plan View
905.EXHIBIT B	Side View
905.EXHIBIT C	End View
905.ILLUSTRATION M	Soil Suitability for On-Site Sewage Design
905.EXHIBIT A	Loading Rates in Square Feet Per Bedroom and Gallons/Square Feet/Day
905.EXHIBIT B	Key for Determining Sewage Loading Rates (Gallons/Square Foot/Day)
905.ILLUSTRATION N	Buried Sand Filter
905.EXHIBIT A	Plan View
905.EXHIBIT B	Section View
905.EXHIBIT C	End View
905.ILLUSTRATION O	Recirculating Sand Filter System
905.EXHIBIT A	System Diagram
905.EXHIBIT B	Flow Splitter Detail

77 ILLINOIS ADMINISTRATIVE CODE 905  
OCTOBER 2013

905.ILLUSTRATION P	Recirculating Sand Filter Sizing Chart
905.ILLUSTRATION Q	Recirculating Tank Pump Control
905.ILLUSTRATION R	Waste Stabilization Pond
905.EXHIBIT A	Plan View
905.EXHIBIT B	Section View
905.EXHIBIT C	Waste Stabilization Pond Surface Area in Square Feet
905.ILLUSTRATION S	Chlorine Contact Tank
905.EXHIBIT A	Minimum Required Chlorine Contact Tank Volume
905.EXHIBIT B	Chlorine Feeder, Contact Tank, and Sampling Port
905.ILLUSTRATION T	Sanitary and Concrete Vault Privy
905.ILLUSTRATION U	Septic Privy Distribution System
905.EXHIBIT A	Plan View
905.EXHIBIT B	Section View
905.ILLUSTRATION V	Sanitary Dump Station
905.EXHIBIT A	Section View #1
905.EXHIBIT B	Plan View
905.EXHIBIT C	Section View #2
905.ILLUSTRATION W	Swimming Pool Backwash Water Holding Tank
905.ILLUSTRATION X	Illinois Raised Filter Bed
905.EXHIBIT A	Sizing Requirements
905.EXHIBIT B	Batch Treatment Aeration Tank Design Requirements
905.EXHIBIT C	Filter Bed Cross Section (Side View)
905.EXHIBIT D	Filter Bed Cross Section (End View)
905.EXHIBIT E	Sizing Requirements Using Soils Investigation Information
905.APPENDIX B	Contact Information for the Central and Regional Offices

AUTHORITY: Implementing and authorized by the Private Sewage Disposal Licensing Act [225 ILCS 225].

SOURCE: Filed October 19, 1974, effective October 25, 1974; rules repealed, new rules adopted at 6 Ill. Reg. 3095, effective March 9, 1982; amended at 8 Ill. Reg. 8552, effective June 4, 1984; codified at 8 Ill. Reg. 19821; amended at 9 Ill. Reg. 20738, effective January 3, 1986; amended at 10 Ill. Reg. 11054, effective July 1, 1986; amended at 20 Ill. Reg. 2431, effective March 15, 1996; amended at 23 Ill. Reg. 5080, effective April 10, 1999; amended at 27 Ill. Reg. 3074, effective February 10, 2003; amended at 37 Ill. Reg. 14994, effective August 28, 2013.

**Section 905.10 Definitions**

In addition to the definitions contained in the Private Sewage Disposal Licensing Act [225 ILCS 225], the following definitions shall apply:

"Act" means the Private Sewage Disposal Licensing Act [225 ILCS 225].

"Aerobic Treatment Plant" means equipment or devices for the treatment of sewage by the forced addition of air or oxygen.

"Ag Experiment Station" means the University of Illinois at Urbana-Champaign Agricultural Experiment Station.

"Approved" or "Approval" means accepted by or acceptable to the Department or local authority.

"Approved Certification Agency" means an organization that has been accredited by the American National Standards Institute (ANSI) and has been found to meet the requirements specified in the International Organization for Standardization (ISO)/International Electrotechnical Commission Guide 65 to evaluate wastewater treatment units and components for compliance with National Sanitation Foundation (NSF) International/ANSI Standards.

"Building Drain" means that part of the lowest horizontal piping of a drainage system that receives the discharge from soil, waste and other drainage pipes inside the walls of the building and conveys it to the building (house) sewer. The building drain's developed length terminates 5 feet outside the building foundation wall.

"Building Sewer" means that part of the horizontal piping of a drainage system that extends from the end of the building drain, receives the discharge of the building drain and conveys it to a public sanitary sewer or private sewage disposal system. The building sewer commences 5 feet outside the building foundation wall.

"Clear Water" means cooling water and condensate water from refrigeration or air conditioning equipment, cooled condensate from steam heating systems and sub-soil drainage.

"Common Collector" means an underground enclosed conduit designed to carry treated sewage effluent exclusive of storm water and that serves more than one property.

"Common Property" means the property that is used by all owners or tenants for a private sewage disposal system.

77 ILLINOIS ADMINISTRATIVE CODE 905  
OCTOBER 2013

"Component" means an integral part of a private sewage disposal system that is necessary for the satisfactory design, construction and operation of the system.

"Discharge Point" means the point at which treated effluent discharges from an approved private sewage disposal system, which is compliant with Section 905.110(a).

"Domestic Sewage" means waste water derived principally from dwellings, business or office buildings, institutions, food service establishments and similar facilities.

"Effective Size" means the size of screen opening where 90 percent by weight of a sample of filter media is retained on the screen and 10 percent passes through the screen.

"Effluent" means treated or partially treated liquid discharged from a private sewage disposal system or a component.

"Estimated Seasonal High Water Table" means the highest level to which the soil is saturated, as determined by direct observation or as may be determined by a Soil Classifier examining additional information.

"Gravelless Seepage System" means the use of approved perforated 8-inch or 10-inch diameter filter-wrapped plastic pipe in lieu of 4-inch pipe and gravel, in subsurface fields and serial distribution systems.

"Hot Tub" means an artificial container of water with a liquid capacity greater than 100 gallons and designed with a mechanical air injection system or recirculating device. These devices may filter or disinfect the water for reuse and are not intended to be drained between uses.

"Influent" means something that flows into a private sewage disposal system or a component.

"Limiting Layer" means a horizon or condition in the soil profile or underlying strata that includes:

An estimated high water table, whether perched or regional.

Masses of loose rock fragments, including gravel, with insufficient fine soil to fill the voids between the fragments.

Rock formation, other stratum or soil condition that is so slowly permeable that it effectively limits downward passage of effluent.

"Liquid Capacity" means the volume of a tank below the invert of the outlet line.

77 ILLINOIS ADMINISTRATIVE CODE 905  
OCTOBER 2013

"Local Authority" means a local unit of government that enforces a private sewage disposal ordinance that has been approved by the Department; or a local health department that has been designated an agent of the State for conduct of the Private Sewage Disposal Program.

"Maintained and Serviced" means the tasks, procedures and inspections required by the manufacturer of the component/system or the Department for the private sewage disposal system to operate within the parameters and requirements of this Part and any other restrictions established as part of the system approval or as part of a variance.

"Minimum Slope" means the slope required for treated effluent to travel in the designed direction of flow.

"Non-Residential Property" means any property that is not residential property.

"NPDES Permit" means any general or individual National Pollutant Discharge Elimination System permit issued by the Illinois Environmental Protection Agency or the United States Environmental Protection Agency.

"NSF International" means the National Sanitation Foundation International, an independent testing laboratory.

"NSF International/ANSI Standard 40 Wastewater Treatment System" means any system that has been certified by an approved certification agency to meet NSF International/ANSI Standard 40, Residential Wastewater Treatment Systems.

"Portable Potable Hand Washing Unit" means a self-contained, movable, potable water unit equipped with a waste-receiving holding container that may be moved or transported from site to site.

"Portable Sanitation Business" means any partnership, company, limited liability company, corporation or individual that sells, rents, leases, transports, services, cleans, sanitizes or maintains a portable toilet or portable potable hand washing unit or pumps, or transports or disposes of waste from portable toilets or portable potable hand washing units.

"Portable Sanitation Technician" means any individual who is certified by the Department to be an employee for a portable sanitation business and who has completed the training required by this Part.

"Portable Sanitation Technician Trainee" means any individual who is certified by the Department as an employee for a portable sanitation business for less than one year.

77 ILLINOIS ADMINISTRATIVE CODE 905  
OCTOBER 2013

"Portable Toilet" means a self-contained, movable unit equipped with a waste-receiving holding container that may be moved or transported from site to site.

"Proper Operation" means operation of a system within the parameters and requirements of this Part, the Act and any other restrictions established as part of the system approval or as part of a variance.

"Residential Property" means a single-family home or multi-family unit that is intended for occupation as living quarters and is not used to conduct any business that generates wastewater or domestic sewage.

"Septage" means the solid and liquid wastes removed from private sewage disposal systems.

"Shall" means that the stated provision is mandatory.

"Soil Boring" means an observation pit, dug by hand or backhoe, or an undisturbed soil core taken intact and undisturbed by a probe.

"Soil Classifier" means one of the following:

A Certified Professional Soil Classifier (CPSC) who is certified by the Illinois Soil Classifiers Association (ISCA) or a certified soil classifier with the American Registry of Certified Professionals in Agronomy, Crops and Soils (ARCPACS).

A person who is a full member or associate member of the Illinois Soil Classifiers Association (ISCA), provided that direct supervision is provided to this person by an ISCA Certified Professional Soil Classifier or ARCPACS certified soil classifier who accompanies the person on at least 25% of the soil investigations and reviews and signs all of that person's soil investigation reports.

"Sub-soil Drainage" means groundwater such as runoff water, seepage water or clear water from the soil that is free from domestic sewage.

"Subsurface Seepage System" means a subsurface seepage field or seepage bed.

"Uniformity Coefficient" means a number obtained by dividing that size of sand in millimeters of which 60% by weight is smaller, by that size of sand in millimeters of which 10% by weight is smaller.

"Waste" means either human waste or domestic sewage or both.

"Wastewater Source" means any equipment, facility or other source of any type whatsoever that discharges wastewater, directly or indirectly, to the waters of the

77 ILLINOIS ADMINISTRATIVE CODE 905  
OCTOBER 2013

State.

"Water Table" means the upper limit of the portion of the soil or rock formation that is completely saturated with water.

Soil science terms used throughout the text of this Part are defined in the Soil Science Society of America, Glossary of Soil Science Terms unless otherwise defined.

(Source: Amended at 37 Ill. Reg. 14994, effective August 28, 2013)



**Section 905.15 Incorporated and Referenced Materials**

The following materials are incorporated or referenced in this Part:

a) The following materials are incorporated by reference:

- 1) NSF International/ANSI Standard 46, Evaluation of Components and Devices Used in Wastewater Treatment Systems (October 22, 2004) published by:

NSF International  
789 Dixboro Road  
Ann Arbor, Michigan 48105

Referenced in Sections 905.40 and 905.120

- 2) NSF International/ANSI Standard 40, Residential Wastewater Treatment Systems (August 1, 2005) published by:

NSF International  
789 Dixboro Road  
Ann Arbor, Michigan 48105

Referenced in Section 905.100

- 3) NSF International/ANSI Standard 41, Non-Liquid Saturated Treatment Systems (March 28, 2005) published by:

NSF International  
789 Dixboro Road  
Ann Arbor, Michigan 48105

Referenced in Section 905.130

- 4) American Society for Testing and Materials (ASTM) required standards and dates that are not listed in subsection (a)(5) are listed under Appendix A, Illustration C. A list of approved plastic pipe for private sewage disposal system uses and standards may be obtained from:

American Society for Testing and Materials  
100 Barr Harbor Drive  
West Conshohocken, Pennsylvania 19428-2959

Referenced in Sections 905.40, 905.60, 905.70

77 ILLINOIS ADMINISTRATIVE CODE 905  
OCTOBER 2013

- 5) The following ASTM standards for the physical properties and characteristics of gravelless drainage pipe, which may be obtained from:

American Society for Testing and Materials  
100 Barr Harbor Drive  
West Conshohocken, Pennsylvania 19428-2959

ASTM D4632-08 (2008)  
ASTM D3786-09 (2009)  
ASTM D737-08 (2008)  
ASTM F662-86 (1992)

Referenced in Section 905.60(c)(2)

- 6) Standard Methods for Examination of Water and Wastewater (21<sup>st</sup> Edition, October 2005) published by:

American Public Health Association  
1015 8<sup>th</sup> Street  
Washington DC 20036

Referenced in Section 905.110

- 7) Glossary of Soil Science Terms (2001) published by:

Soil Science Society of America  
677 South Segoe Road  
Madison, Wisconsin 53711

Referenced in Section 905.10

- 8) Standards for the Use or Disposal of Sewage Sludge (40 CFR 503) (2008)

Referenced in Section 905.170

- 9) National Electrical Code, 2005 Edition, published by:

National Fire Protection Association  
1 Batterymarch Park  
Quincy, Massachusetts 02269

Referenced in Section 905.20

- 10) International Organization for Standardization (ISO)/International Electrotechnical Commission (IEC) Guide 65 (December 18, 2006), published by:

77 ILLINOIS ADMINISTRATIVE CODE 905  
OCTOBER 2013

ISO Central Secretariat  
International Organization for Standardization (ISO)  
1, ch. de la Voie-Creuse  
Case postale 56  
CH-1211 Geneva 20  
Switzerland

IEC Central Office  
3, rue de Varembe  
PO Box 131  
CH-1211 Geneva 20  
Switzerland

Referenced in Section 905.100

- 11) Field Book for Describing and Sampling Soils ver. 2.0 (2002 Edition)

National Resources Conservation Service  
US Department of Agriculture  
1400 Independence Ave., SW  
Washington DC 20250

Referenced in Section 905.55

- 12) Soil Taxonomy 1999 (2<sup>nd</sup> edition)

US Department of Agriculture  
1400 Independence Ave., SW  
Washington DC 20250

Referenced in Section 905.55

- 13) Soil Survey Manual 1993

Soil Conservation Service  
US Department of Agriculture  
1400 Independence Ave., SW  
Washington DC 20250

Referenced in Section 605.55

- b) The following materials are referenced in this Part:

- 1) Department of Public Health administrative rules and statutes

77 ILLINOIS ADMINISTRATIVE CODE 905  
OCTOBER 2013

- A) Illinois Plumbing Code (77 Ill. Adm. Code 890)  
Referenced in Sections 905.20, 905.140, 905.150 and Appendix A, Illustration C
  - B) Recreational Area Code (77 Ill. Adm. Code 800)  
Referenced in Section 905.150
  - C) Practice and Procedure in Administrative Hearings (77 Ill. Adm. Code 100)
  - D) Plumbing License Law [225 ILCS 320]
- 2) Pollution Control Board administrative rules and statutes
- A) Introduction (35 Ill. Adm. Code 301)  
Referenced in Section 905.110
  - B) Permits (35 Ill. Adm. Code 309)  
Referenced in Sections 905.110 and 905.170
  - C) Waste Disposal (35 Ill. Adm. Code Subtitle G)  
Referenced in Sections 905.20 and 905.140
  - D) Classification of Injection Wells (35 Ill. Adm. Code 704.106)  
Referenced in Appendix A, Illustration D
- 3) Illinois Department of Transportation Standard Specifications for Road and Bridge  
Construction (January 1, 2007) published by:
- Illinois Department of Transportation  
Manuals Office, Room 128  
2300 S. Dirksen Parkway  
Springfield, Illinois 62764
- Referenced in Section 905.95
- 4) Illinois Highway Code [605 ILCS 5/9-123]

77 ILLINOIS ADMINISTRATIVE CODE 905  
OCTOBER 2013

Referenced in Section 905.110

- c) All incorporations by reference of federal regulations and the standards of nationally recognized organizations refer to the regulations and standards on the date specified and do not include any amendments or editions subsequent to the date specified.
- d) All citations to federal regulations in this Part concern the specified regulation in the 2005 Code of Federal Regulations, unless another date is specified.
- e) All materials incorporated by reference are available for inspection and copying at the Illinois Department of Public Health, Division of Environmental Health, 525 West Jefferson, Springfield, Illinois 62761.

(Source: Amended at 37 Ill. Reg. 14994, effective August 28, 2013)

**Section 905.20 General Requirements**

- a) **Rate of Flow for Domestic Sewage.** Each unit of the private sewage disposal system shall be designed to treat the volume of domestic sewage discharged to it. The volume of sewage flow shall be determined from Appendix A, Illustration A. For non-residential establishments, the Department will consider the use of actual flow volumes obtained from similar installations in lieu of the quantities contained in Appendix A, Illustration A, when the flow data is documented. Examples of the documentation that could be accepted would be actual measurements of the quantity of wastewater, or water use receipts. In the design of a private sewage disposal system, peak flows shall be designed for or attenuated.
- b) **Type of Waste.** A private sewage disposal system shall be designed to receive all waste from the buildings served.
  - 1) **Prohibited Influent.** No sub-soil drainage, discharge from roof drains or swimming pool wastewater shall be directed to the private sewage disposal system.
  - 2) **Hot Tub Wastewater.** Wastewater generated by a hot tub or similar device shall be discharged to one of the following:
    - A) A separate subsurface seepage system, provided that the seepage field is designed to accommodate the liquid capacity of the hot tub on a daily basis. A septic tank is not required in front of a seepage field receiving flow from this device.
    - B) The seepage field serving the domestic wastewater flow, provided the seepage field is increased in size to accommodate the additional flow from the hot tub on a daily basis. This drainage shall be piped around the septic tank and directly into the seepage field.
  - 3) **Motorized Equipment.** Waste products, such as automotive grease, oils, solvents and chemicals, shall not discharge to a private sewage disposal system. These waste products shall be handled according to rules for disposal of oil, gas and grease promulgated under the Environmental Protection Act, or according to 35 Ill. Adm. Code, Subtitle G, or shall be taken to an oil and gas reclamation center. The floor drain of any non-residential property that meets the requirements of subsection (b)(3)(A) or (B), and is connected to a public sewer, shall be connected to an approved gas and oil interceptor meeting the requirements of Section 890.520 of the Illinois Plumbing Code. Wastes from floor drains in areas where vehicles or motorized equipment are serviced and parked shall be treated in accordance with the following:

77 ILLINOIS ADMINISTRATIVE CODE 905  
OCTOBER 2013

- A) For any non-residential property in which a floor drain may receive fluids from vehicle or motorized equipment repair or maintenance activities, floor drains shall be connected to a public sewer or holding tank and not to a private sewage disposal system. Repair and maintenance facilities shall include, but shall not be limited to, service stations and auto body, muffler, transmission, small engine, and brake repair shops. Floor drains in any facility that performs vehicle or motorized equipment repair work shall be connected to a public sewer or holding tank. If the floor drain is connected to a public sewer, then the floor drain shall be connected to an approved gas and oil interceptor meeting the requirements of Section 890.520 of the Illinois Plumbing Code. If the floor drain is connected to a holding tank, a gas and oil interceptor is not required. The holding tank shall be constructed of the same materials required for gas and oil interceptors.
  - B) For any non-residential property on which vehicles or motorized equipment are parked or stored and repair or maintenance is not performed, floor drains shall discharge to a public sewer or a private sewage disposal system, provided that floor drains are used only to receive water from motorized equipment or vehicle washing or to drain melted snow. When floor drains in such properties are connected to a private sewage disposal system, the system shall be increased in size based upon the anticipated daily flow. When a maintenance area is adjacent to a parking area, physical barriers, such as a raised curb or recessed floor in the maintenance area, shall be provided to assure that oil and gas are not discharged to floor drains.
  - C) For any residential property with a garage of any size, floor drains may discharge directly to a private sewage disposal system. No increase in size of the residential private sewage disposal system is required to handle this liquid waste.
- 4) Drains or fixtures receiving any product other than domestic sewage or wastewater specified in subsection (b)(2) shall be discharged to an approved treatment or disposal system that is regulated and approved by the State or to a holding tank and not to a private sewage disposal system.
  - 5) Water Softener Wastewater. Backwash water from a water softener or similar device shall be discharged to one of the following:
    - A) A separate subsurface seepage system, provided that the seepage field is designed to accommodate the liquid capacity of the water

softener on a daily basis. A septic tank is not required in front of a seepage field receiving flow from this device.

B) A separate building drain, in accordance with the Illinois Plumbing Code, that will discharge to a subsurface seepage system, provided that the seepage field is designed to accommodate the flow from this device on a daily basis. A septic tank is not required in front of a seepage field receiving flow from this device.

- c) Individual Service. The use of a private sewage system to serve more than one property is prohibited except where a common property is provided, under joint ownership of the users, or where the system is under public jurisdiction or managed by a district established for the maintenance of these systems.
- d) Water and Sewer Line Separation. The following criteria shall govern the separation of water supply lines and sewer lines:
  - 1) Horizontal Separation. Sewers shall be installed at least 10 feet horizontally from any existing or proposed water line. When local conditions prevent a lateral separation of 10 feet, a sewer may be laid closer than 10 feet to a water line provided that the elevation of the crown of the sewer is at least 18 inches below the invert of the water line.
  - 2) Crossings. Where sewer lines must cross water lines, the sewer line shall be laid at an elevation so that the crown of the sewer line is at least 18 inches below the invert of the water line. This vertical separation shall be maintained for that portion of the sewer line located within 10 feet horizontally of any water line it crosses. When sewer lines must cross above water lines, the sewer lines shall be Schedule 40 or equivalent material with watertight joints.
- e) Sanitary Sewer. New or renovated private sewage disposal systems shall not be approved where a sanitary sewer operated and maintained under permit of the Illinois Environmental Protection Agency is available for connection. A sanitary sewer is available for connection when it is within 300 feet of a residential property or a non-residential property with a sewage flow less than 1500 gallons per day, or within 1000 feet of a non-residential property with a sewage flow greater than or equal to 1500 gallons per day, unless a physical barrier or local ordinance exists that prevents connection to the sewer. If connection from the property to the sanitary sewer cannot be made with an individual line (i.e., 4" inch line), then a private sewage disposal system may be installed.
- f) Acceptable Pipe Materials
  - 1) All piping located more than 5 feet from the building foundation, used to convey wastewater to a private sewage disposal system, shall be



considered a part of the private sewage disposal system and shall be watertight. This piping shall be ductile iron, vitrified clay or plastic pipe. Only vitrified clay or plastic pipe shall be used from the septic tank and after the distribution box (where used). Perforated pipe or open-jointed tile shall be used only as provided in this Part.

- 2) Use of plastic pipe and fittings shall comply with the uses designated in Appendix A, Illustration C.
  - 3) Piping used to carry domestic sewage under areas such as driveways, roads or parking areas shall be Schedule 40 equivalent or greater.
- g) Pipe Size and Slope
- 1) All solid pipes carrying domestic sewage by gravity flow shall have a nominal diameter of at least 4 inches and a minimum slope of 12 inches per 100 feet.
  - 2) Solid header lines used for equal distribution shall be level.
  - 3) Solid pipes carrying treated effluent by gravity shall have a nominal diameter of 4 inches and a minimum slope to ensure designed flow within the system.
  - 4) An alternative design for pipe sizing and slope may be proposed by an Illinois licensed Professional Engineer.
- h) Prohibited Discharges. There shall be no discharge of raw or improperly treated domestic sewage to the surface of the ground or to farm tiles, streams, rivers, ponds, lakes or other collectors of water. Improperly treated domestic sewage is sewage that does not meet the effluent requirements of Section 905.110(d) or sewage that comes directly from a septic tank or building sewer. Domestic sewage or effluent from any private sewage disposal system or component shall not be discharged into any well, cistern or basement or into any underground mine, cave, sinkhole or tunnel.
- i) Pipe Length. Building sewers in excess of 50 feet in length that carry wastewater from the buildings served to the septic tank, distribution box or aeration treatment plant shall be provided with at least one clean-out every 50 feet that terminates at grade.
- j) Private Sewage Disposal System Development. The following factors shall govern the development of a private sewage disposal system:
- 1) Drainage. A private sewage disposal system shall not be located in areas where surface water will accumulate. The flow of surface water over the

77 ILLINOIS ADMINISTRATIVE CODE 905  
OCTOBER 2013

private sewage system shall be minimized, for example, by the use of dikes, embankments, ditches or flow diverters.

- 2) Distances. The location of the various components of a private sewage disposal system shall comply with Appendix A, Illustration D.
- 3) Area Reserved for Sewage Disposal. The area to be used for a private sewage disposal system shall be selected and maintained so that it is free from encroachment by driveways, accessory buildings, swimming pools, parking areas, buried lawn sprinkling systems and underground utility services, patios, slabs, additions to the original structure, or any other structure that limits free access to the system for maintenance, servicing or proper operation. The property owner and private sewage disposal system installation contractor shall ensure that the designated area for the subsurface seepage system shall be secured prior to construction or modifications to the site and shall be protected throughout the site development or construction process. The property owner and private sewage disposal system installation contractor shall secure this area to deter any traffic, compaction of the soil, removal or addition of soil, or encroachment on the area of the proposed subsurface seepage system. Temporary fencing, posts and roping or a similar restrictive barrier may be used to restrict access. The area of the proposed private sewage disposal system shall be protected throughout the site development or construction process.
- 4) Creviced Limestone Formations. A subsurface seepage system shall not be constructed in an area where there is less than 4 feet of soil between the lowest point in a subsurface seepage system and the top of a creviced limestone formation. In areas where creviced limestone is known to occur, a soil boring to a depth of at least 4 feet below the bottom of the subsurface seepage system shall be made to verify that creviced limestone is not present.

k) Electrical Devices. All electrical devices shall be wired in accordance with the National Electrical Code or a municipal, county or local electrical code, whichever is more stringent.

- 1) Any component of a private sewage disposal system that is electrically activated shall be provided with a visible and audible warning device.
- 2) Alarms installed after January 1, 2014 shall be located outside of the building served. The power supply for the alarm shall be on a dedicated circuit. The design of the alarm shall meet the requirements specified in Section 5.8 of NSF International/ANSI Standard 40. The alarm shall be housed in a weatherproof box.

- 3) Electrical devices installed after January 1, 2014 shall be provided with an electrical disconnect that is located within sight of, and not more than 50 feet away from, the device.
- l) Variances. If conditions exist at a proposed installation that make compliance with the requirements of this Part impractical or impossible, a variance may be requested by submitting to the Illinois Department of Public Health, Division of Environmental Health, or appropriate local authority a written proposal that is to be used in lieu of compliance with this Part. The written request shall include pertinent data to support the proposal, such as soil conditions, water table elevations, drainage patterns and distances to water supplies. The capability of the system to comply with the intent of this Part will be the basis for approval or denial of the variances. The Department or local authority will notify the applicant in writing of its decision to either grant or deny the variance. Construction shall not begin before a variance is requested and approved.
- m) Experimental Use Permits. If a private sewage disposal system or component is of a new or innovative type and does not comply with the requirements of this Part, the homeowner or private sewage contractor or manufacturer may request an experimental use permit. A request shall be submitted in writing to the Illinois Department of Public Health, Division of Environmental Health, and construction or installation shall not begin before a permit is requested and approved. The request shall meet the following requirements:
  - 1) The request shall specify the type of proposed system or component to be used and shall be accompanied by plans, specifications and engineering data to support the system's compliance with the general requirements under Section 905.20 and with the effluent criteria under Section 905.110 for surface discharges, if applicable.
  - 2) Information (such as topographical or plat maps) regarding the location of each installation shall be provided to the Department.
  - 3) The homeowner, private sewage disposal system installation contractor or manufacturer shall provide the Department with proof that sufficient area is available for installation of an approved system if the experimental system fails.
  - 4) The homeowner, private sewage disposal system installation contractor or manufacturer shall guarantee in writing that the experimental system will be replaced with an approved system if the experimental system fails to perform in accordance with any of the Sections of this Part, or with criteria established as a condition of approval of the system.
  - 5) The private sewage disposal system installation contractor or the manufacturer shall notify the homeowner, or the person obtaining the

77 ILLINOIS ADMINISTRATIVE CODE 905  
OCTOBER 2013

experimental use permit, of the guarantee required by subsection (m)(4), and of the minimum standards of this Part that shall be met, as determined through the process described in subsections (n)(3) and (4) for developing criteria to be used in the evaluation of the experimental system.

- 6) Upon receipt of the information required by this subsection (m), the Department will review the experimental system to determine whether the proposed system is equal to or more stringent than applicable Sections in this Part, and will notify the applicant, in writing, of its decision to approve or deny the request for an experimental use permit. If the request is approved, the Department will issue an Experimental Use Permit for each installation, up to 30 installations in the State.

n) Experimental Use Evaluation

- 1) A minimum of 10 experimental installations shall be evaluated before an unconditional approval will be granted.
- 2) The experimental permit shall be valid for a period of up to 2 years, during which time the Department will evaluate the performance of the experimental system. At the end of the 2 year evaluation period, the Department will determine whether the system will be approved.
- 3) The Department, in consultation with the experimental use permit applicant, will develop a test method for the experimental system, which will include the following information:
  - A) purpose of the test;
  - B) length of the test;
  - C) analytical methods to be used;
  - D) wastewater characteristics;
  - E) loading requirements; and
  - F) test criteria, including installation procedures, operating procedures, site evaluation criteria, control system criteria, start-up procedures, sampling procedures, and observation procedures.
- 4) The Department, in consultation with the permit applicant, will develop performance requirements that will detail the criteria to be used to evaluate the product to determine its ability to become an approved private sewage disposal system. The performance requirements shall include, but are not limited to, ponding in subsurface systems indicating that failure of

77 ILLINOIS ADMINISTRATIVE CODE 905  
OCTOBER 2013

the system is imminent.

- 5) The experimental system will be deemed unacceptable:
  - A) when sewage erupts from the ground;
  - B) when effluent from the system does not meet the criteria of Section 905.110(d); or
  - C) when the experimental system does not comply with the requirements of subsections (n)(3) and (4).
- 6) If the experimental system is acceptable, it shall become an approved private sewage system. If the experimental system is unacceptable, it shall not be approved for use as a private sewage disposal system and shall be replaced with an approved private sewage disposal system. The Department shall notify the applicant, in writing, of its determination.
- 7) A homeowner, private sewage contractor or manufacturer whose experimental system has been denied approval for use as a private sewage disposal system may request a hearing to appeal the Department's determination. The request shall be submitted in writing within 10 days after receipt of the Department's determination. The Department's Practice and Procedure in Administrative Hearings rules shall apply to all proceedings conducted under this Section.
- 8) When the Department has designated an experimental system as an approved private sewage disposal system, the Department will amend this Part to include design, construction, operation and maintenance criteria for the newly approved system and will add the system to its list of approved systems.
- o) Garbage Grinders. When garbage grinders are used in residential property, solids shall be retained by one of the following methods:
  - 1) A solids retention tank constructed in accordance with Section 905.40 shall be placed between the wastewater source and the septic tank to intercept solids from the garbage grinder. This tank shall receive waste from the garbage grinders or the kitchen wastes only. No other fixtures shall discharge into this tank. The solids retention tank shall be at least 50% in liquid volume of the septic tank sized for the waste from the rest of the property; however, the minimum size tank to be used shall be 500 gallons.
  - 2) A septic tank receiving all flows from the property sized in accordance with Appendix A, Illustration F.

- p) Whenever an existing private sewage disposal system is repaired or replaced, that portion of the system being repaired or replaced shall comply with all of the requirements of this Part.

q) **Maintenance of Private Sewage Disposal Systems**

- 1) After January 1, 2014, as a condition of applying for an installation approval required by Section 905.190, the signature by the property owners on the installation approval submission/construction permit for any private sewage disposal system being installed, repaired or renovated serves as written acknowledgement that the property owners are aware of and accept the responsibility to service and maintain the private sewage disposal system in accordance with the Act and this Part.
- 2) The property owner or the private sewage disposal system owner shall maintain all maintenance records on forms provided or approved by the Department and make records available upon request by the Department or Local Authority. These records shall be transferred from owner to owner. Records shall be kept for the life of the system.
- 3) After January 1, 2014, private sewage disposal systems installed and permitted under Section 905.190 are required to be maintained and serviced to ensure proper operation in accordance with the following:
  - A) Septic tank to a subsurface seepage system or septic tank followed by a sand filter discharging to a subsurface seepage system.
    - i) Private sewage disposal system septic tanks serving residential properties shall be evaluated prior to or within 3 years after the date of installation of the system. The system may be evaluated by the homeowner, a Private Sewage Disposal System Installation Contractor, a licensed Environmental Health Practitioner, an Illinois licensed Professional Engineer, a representative of the Department, or an agent of the Department or local health department. The evaluation shall determine whether the tanks and all of the compartments of the private sewage disposal system have layers of scum and settled solids greater than 33% of the liquid capacity of the tank. If the layers of scum and settled solids are greater than 33%, the tanks and compartments shall be pumped out and maintenance shall be performed. After the first evaluation, the system shall be evaluated a minimum of once every 5 years. Depending on the system's use, the tanks and compartments may need to be evaluated and pumped more frequently.

ii) Private sewage disposal system septic tanks serving non-residential property shall be evaluated within 3 years after the date of installation of the system. The system may be evaluated by a Private Sewage Disposal System Installation Contractor, a licensed Environmental Health Practitioner, an Illinois licensed Professional Engineer, a representative of the Department, or an agent of the Department or local health department. The evaluation shall determine whether the tanks and all of the compartments of the private sewage disposal system have layers of scum and settled solids greater than 33% of the liquid capacity of the tank. If the layers of scum and settled solids are greater than 33%, the tanks and compartments shall be pumped out and maintenance shall be performed. After the first evaluation, the system shall be evaluated at minimum once every 3 years. Depending on the system's use, the tanks and compartments may need to be evaluated and pumped more frequently.

B) An aerobic treatment unit (ATU) requires evaluation and maintenance at least once every 6 months. The system may be evaluated by a Private Sewage Disposal System Installation Contractor, a licensed Environmental Health Practitioner, an Illinois licensed Professional Engineer, a representative of the Department, or an agent of the Department or local health department. The homeowner of an ATU may conduct the inspection and maintenance as defined within the Act, but the inspection and maintenance shall be performed per the manufacturer's requirements to assure proper operation. If the required inspections and maintenance are not performed, the system is in violation of the Act and this Part.

C) Sand filters and waste stabilization ponds with surface discharges require an evaluation to determine whether the tanks and all of the compartments of the private sewage disposal system have layers of scum and settled solids greater than 33% of the liquid capacity of the tank. If the layers of scum and settled solids are greater than 33%, the tanks and compartments shall be pumped out and maintenance shall be performed. The system shall be evaluated a minimum of once every year. The system may be evaluated by a Private Sewage Disposal System Installation Contractor, a licensed Environmental Health Practitioner, an Illinois licensed Professional Engineer, a representative of the Department, or an agent of the Department or local health department. Depending on the system's use, the tanks and compartments may need to be

- evaluated and pumped more frequently. The homeowner of a sand filter or waste stabilization pond may conduct the inspection and maintenance as defined within the Act, but the inspection and maintenance shall be performed per the requirements of this Part to assure proper operation.
- D) All other private sewage disposal systems that are not listed in subsection (q)(3)(A) through (C) shall be maintained in accordance with the manufacturer's specifications or based on a maintenance interval approved by the Department.
- E) The owner of a private sewage disposal system may submit an alternative maintenance interval to the Department for approval. The Department will evaluate the alternative interval on a case-by-case basis. The approval is not transferable from owner to owner. Change in ownership or use of the private sewage disposal system will void the approval.
- 4) A failure to properly operate, maintain and have routine service conducted on a private sewage disposal system is a violation of the Act and this Part.
- r) **Installation Contractor On Site.** A licensed Private Sewage Disposal System Installation Contractor shall be present at the site during construction, installation, repair, modification or maintenance of a private sewage disposal system. Cleaning, pumping, disposing and hauling of waste from a private sewage disposal system shall be done by a licensed Private Sewage Disposal System Pumping Contractor. *A person who owns and occupies a single family dwelling and who constructs, installs, maintains, services or cleans the private sewage disposal system which serves his/her single family residence shall not be required to be licensed under this Section; however, such person shall comply with all other provisions of the Act and this Part. (Section 4 of the Act)*
- s) **Construction and Excavation.** Any construction or excavation performed by any individual other than the person who owns and occupies a single family dwelling shall be performed by a licensed Private Sewage Disposal System Installation Contractor or an individual under the direct supervision of a licensed Private Sewage Disposal Installation Contractor.
- t) **Alternative Technology.** The Department may issue approval for a private sewage disposal system or a system component that has been approved by another governmental body or an approved certification agency, based upon, but not limited to, the review of the following information: submittals to other governmental bodies; analysis from third party testing; testing results from other governmental bodies; and historical use within the jurisdiction of other governmental bodies.

(Source: Amended at 37 Ill. Reg. 14994, effective August 28, 2013)



**Section 905.30 Approved Private Sewage Disposal Systems**

- a) The following systems are approved for private sewage disposal when designed, constructed, operated, and maintained in accordance with this Part:
  - 1) Septic tank, Imhoff tank or aerobic treatment plants followed by:
    - A) Subsurface seepage field;
    - B) Seepage bed;
    - C) Sand filter (buried or re-circulating);
    - D) Waste stabilization pond;
    - E) 8 inch or 10 inch gravelless seepage system;
    - F) Chamber system;
    - G) Peat filter system; or
    - H) Subsurface drip irrigation system.**
  - 2) Aerobic treatment plant and NSF International/ANSI Standard 40 wastewater treatment systems discharging to supplementary treatment or to the surface, as provided in Sections 905.100 and 905.110.
  - 3) Privies, chemical toilets, re-circulating toilets, incinerator toilets or compost toilets.
  - 4) Holding tanks installed in accordance with Section 905.140.
  - 5) Any other system for which a variance in accordance with Section 905.20(l) has been issued or for which an experimental permit in accordance with Section 905.20(m) has been issued.
  - 6) Illinois raised filter bed preceded by a batch treatment aeration system.
  - 7) Technologies approved by the Department under Section 905.20(t).**
- b) The Department will maintain a list of alternative components and technologies that have been approved under the Act. This list will be available at <http://www.idph.state.il.us/envhealth/prisewage.htm>.**
- c) All other systems or components not listed under this Part are not approved.**

(Source: Amended at 37 Ill. Reg. 14994, effective August 28, 2013)

**Section 905.40 Septic Tanks**

- a) Septic Tank Approval. Manufacturers of prefabricated septic tanks shall submit a set of plans for each size and configuration of septic tank to the Department for approval. Plans shall be drawn to scale and show all dimensions, baffles, tees, cleanouts and material specifications. The Department will provide a written approval for each size tank when the plans are found to conform to the requirements of this Part.
- 1) The Department will issue an approval number to each manufacturer for each series of approved septic tanks and will maintain a listing of the approved manufacturers and approved septic tank series.
  - 2) No prefabricated septic tank shall be sold, offered for sale, or installed other than those which have been approved by the Department. The tank shall bear the manufacturer's approval number and the liquid capacity of the tank, in gallons, prominently displayed on the outside end wall of the tank above, or next to, the outlet pipe so that this information is readily visible after installation and prior to covering. The Illinois Department of Public Health approval number shall not be used on any tank other than the septic tank for which it is has been issued.
  - 3) All persons who manufacture, sell, offer for sale or deliver septic tanks or aerobic treatment plants in or into the State of Illinois shall record the following information about each septic tank or aerobic treatment plant sold or delivered. This information shall be available for inspection by the Department or local authority upon request.
    - A) Name of purchaser or property owner (if different);
    - B) Location of delivery (county and address, legal description or driving directions);
    - C) Date of sale and delivery; and
    - D) Size of septic tank or model of aerobic unit.
- b) Septic Tank Construction. Septic tanks shall be designed and constructed in accordance with the following: (Appendix A, Illustration E is an illustration of these requirements.)
- 1) A septic tank shall be watertight and constructed of sound and durable materials not subject to excessive corrosion, decay, frost damage or cracking due to settling or backfilling.
  - 2) Engineering Specifications

77 ILLINOIS ADMINISTRATIVE CODE 905  
OCTOBER 2013

- A) The tank shall support a top-dead load of not less than 500 pounds per square foot, and concrete tanks shall have a minimum 28-day compressive strength of 3000 pounds per square inch (psi).
  - B) Tanks shall be designed and constructed so that they will not collapse or rupture when subjected to anticipated earth and hydrostatic pressures when the tanks are either full or empty. The manufacturer, design engineer or structural engineer shall certify in writing to the Department that the tank is designed and constructed to meet the load requirements of this Part. If additional loading is anticipated, the tank shall be strengthened to accommodate the additional loading.
- 3) Materials. Septic tanks shall be constructed of any of the following approved materials:
- A) Poured-in-place reinforced concrete.
  - B) Precast reinforced concrete.
  - C) Concrete block, provided that the core is filled with concrete and reinforcing rods are inserted in the core prior to pouring.
  - D) Reinforced plastic.
  - E) Reinforced fiberglass.
  - F) Thermoplastic.
- 4) Depth. The minimum liquid depth of the tank shall be 42 inches, and the maximum liquid depth shall be 72 inches.
- 5) Inlet and Outlet Connections
- A) The invert elevation of the inlet shall be at least 2 inches above the liquid level in the tank.
  - B) The inlet and outlet openings of the septic tank shall be provided with cast-in watertight openings.
- 6) Baffles. Septic tank baffles shall meet the following requirements:
- A) Inlet baffles shall be provided and shall extend at least 6 inches below the surface of the liquid.

77 ILLINOIS ADMINISTRATIVE CODE 905  
OCTOBER 2013

- B) Inlet baffles shall be located no farther than 12 inches from the inlet orifice.
- C) Inlet and outlet baffles shall have a clearance of at least one inch but not greater than 3 inches of free space between the underside of the tank lid and the baffles.
- D) Outlet baffles shall be provided and shall extend to a depth of 40% of the liquid depth.
- E) Outlet baffles shall be located no farther than 6 inches from the outlet end wall.
- F) Slip-in baffles shall extend the full width of the tank.
- G) The sides of "V" or semi-circular type baffles shall fit tightly against the end wall of the tank.
- H) Venting shall be provided through all baffles and a free vent area equal to the cross-sectional area of the building shall be provided.
- I) Submerged pipe T-branches or sanitary tees may be used at the inlets and outlets in lieu of baffles, provided that all of the above-stated distances and depths are maintained.
- J) Submerged pipe T-branches or sanitary tees used as inlet baffles shall be 6 inches in diameter or larger. Outlet baffles shall be 4 inches in diameter.
- K) Submerged pipe T-branches or sanitary tees shall meet the requirements of ASTM 2661, ASTM 2665 or ASTM 3034, or ASTM 2751, provided that the pipe does not have an SDR (Standard Dimension Ratio) number greater than 35.
- L) When submerged pipe T-branches or sanitary tees are used as baffles, it shall be the responsibility of the septic tank manufacturer to assure proper location of components during initial installation.
- M) When a single compartment septic tank is manufactured or used, a gas deflection baffle shall be provided below the outlet baffle of the tank configured to deflect rising gas bubbles away from the outlet structure and toward the interior of the tank. This baffle shall be constructed of a durable material not subject to corrosion or decay. (Appendix A, Illustration E, Exhibit C is an illustration.)  
An NSF International/ANSI Standard 46, Section 10 septic tank filter may be used in lieu of the gas deflector baffle. The septic

tank filter baffle shall be installed so that it is extended or suspended to a depth equal to 40% of the liquid level of the tank. The tank access over the filter shall be provided with an access riser that extends to 3 inches above the ground surface or greater.

- 7) Access. Access shall be provided over the inlet and outlet of the tank to facilitate inspection and cleaning. The manhole or access opening shall have a fitted lid with a minimum dimension of 12 inches (width or diameter). Risers shall be watertight and constructed of a durable material. If the top of the tank is greater than 12 inches below the ground surface, a riser with a minimum dimension of 12 inches (width or diameter) shall be provided to bring access over the inlet and outlet to within 12 inches of the ground surface. The joint between the septic tank and the risers shall be watertight. If a 2-compartment tank is used, and the tank has an opening over the wall between the compartments, the center opening shall have access provided within 12 inches of the ground surface.
- c) Capacity
- 1) Septic tanks for individual residences shall be sized in accordance with Appendix A, Illustration F. Septic tanks for any establishment other than residential property shall be sized in accordance with the estimated flow provided in Appendix A, Illustration A and as provided in subsection (c)(2).
  - 2) The volume below the liquid level for flows up to 500 gallons per day shall be at least 750 gallons. For flows greater than 500 gallons per day, the volume shall be equal to at least 1½ the estimated daily sewage flow. When the total flow exceeds 1,350 gallons per day, 2 or more tanks in series, or a multi-compartment tank, shall be installed.
- d) Multiple Tanks or Compartments. When multiple compartment septic tanks or multiple septic tanks in series are used, the capacity of the first compartment or tank shall be ½ to ⅔ of the total required capacity. Two-compartment tanks shall also comply with the following:
- 1) The wall separating the first and second compartments shall be tight-fitting and designed to handle the differential in pressure if one side is pumped.
  - 2) The wall separating the compartments shall extend to within 3 inches of the tank lid and shall have a free vent area equal to the cross-sectional area of the house sewer.
  - 3) The center of the opening between compartments shall be in line with the center of the inlet and outlet openings.

77 ILLINOIS ADMINISTRATIVE CODE 905  
OCTOBER 2013

- 4) The depth to the invert of the opening between compartments shall be 40% of the liquid depth.
- 5) A gas deflection baffle shall be provided below the outlet baffle of the tank configured to deflect rising gas bubbles away from the outlet structure and toward the interior of the tank. This baffle shall be constructed of a durable material that is not subject to corrosion or decay. An NSF International/ANSI Standard 46, Section 10 septic tank filter may be used in lieu of the gas deflector baffle. The septic tank filter baffle shall be installed so that it is extended or suspended to a depth equal to 40% of the liquid level of the tank. The tank access over the filter shall be provided with an access riser that extends to 3 inches or more above the ground surface.
- 6) For a 2-compartment tank, openings with a minimum dimension of 18 inches shall be located over the inlet and outlet of the tank or 12-inch openings as follows:
  - A) One located over the inlet;
  - B) One over the outlet; and
  - C) One centered over the compartment wall.
- e) Septic Tank Installation
  - 1) The septic tank shall be set level and backfilled to prevent floatation or drifting of the tank. Level shall mean plus or minus ½ inch in any direction (length or width or diameter of the tank).
  - 2) If the inlet, outlet or access openings are to be set at or below the seasonal high water table, all openings in the tank shall be made watertight using mastic, tar, silicone caulk, etc.
  - 3) There shall be no connections, such as joints, splices or fittings, within the area of overdig around the septic tank.
- f) Abandoned Treatment Units. Septic tanks, cesspools, pit privies, aerobic treatment plants and seepage pits that are no longer in use shall be completely pumped. The floor and walls shall be cracked or crumbled so that the tank will not hold water, and the tank shall be filled with sand or soil. If the tank is removed from the ground, the excavation shall be filled with soil.

(Source: Amended at 37 Ill. Reg. 14994, effective August 28, 2013)

**Section 905.50 Distribution Boxes**

- a) General. Distribution boxes may be installed between a septic tank, aerobic treatment plant, NSF International/ANSI Standard 40 wastewater treatment system, and a subsurface seepage system or buried sand filter. If a distribution box is used, it shall be installed level on unexcavated earth, and shall provide equal distribution of flow to the subsequent disposal system.
- b) Connecting Pipe. The pipe connecting the pre-treatment or primary treatment component to the distribution box and the pipe connecting the distribution box to the disposal system shall be watertight.
- c) Construction. Distribution boxes shall be constructed of a durable, watertight, non-corrosive material. They shall be designed to accommodate the necessary distribution lines.
- d) Access. Distribution boxes shall be provided with an opening that will serve as a ready access for inspection, cleaning and general maintenance.
- e) There shall be no connection such as joints, splices or fittings within the area of the overdig around the distribution box.

(Source: Amended at 37 Ill. Reg. 14994, effective August 28, 2013)

**Section 905.55 Subsurface Seepage System Design Requirements**

After January 1, 2014, when designing a subsurface seepage system, the absorption capacity of the soil shall be determined by subsection (a). After January 1, 2014, subsection (b) shall not be used to determine design requirements for a subsurface system.

- a) Soil Investigation
  - 1) Soil investigations shall be conducted in the following manner:
    - A) Determination of soil characteristics on sites proposed for development with private sewage disposal systems shall be based on soil boring data collected by a soil classifier or an Illinois licensed Professional Engineer.
    - B) There shall be a minimum of 3 borings per soil absorption system site. The soil borings shall be at least 50 feet apart, and the proposed subsurface seepage system shall be located within the area where the soil borings were located. More soil borings may be necessary for accurate and appropriate evaluation of a site where there is some concern about the consistency of the soil materials. One of the borings shall be made at the lowest elevation of the proposed absorption field area. Borings shall extend a minimum of 60 inches below the natural ground surface. An observation pit shall be used in gravelly materials.
    - C) Observation and determination of soil characteristics may also be determined from a pit dug by a backhoe or other excavating equipment. The Department or local authority may require soil pits (backhoe excavation) in cases where ground is frozen, where the soil materials are considerably varied in texture, where there has been previous or current fill material or cutting of soils, or where gravelly soils are encountered. Soil pits shall be prepared at the perimeter of the expected soil absorption area to minimize damage to natural soil structure. Soil pits shall extend a minimum of 60 inches below the natural ground surface.
    - D) Site characteristics to be described include zones of seasonal and permanent water saturation, United States Department of Agriculture (USDA) soil textural changes; USDA soil structural features for each horizon, slope, compaction and depth; soil coloration; consistence; coatings; depth of limiting layer; depth of soil mottling; internal drainage classification; permeability range; and other limiting soil characteristics that may reduce permeability. The following reference materials shall be used as a guide for describing and classifying soil: Field Book for



Describing and Sampling Soils, Soil Taxonomy, and Soil Survey Manual.

- 2) The following persons are qualified to conduct soil investigations:
    - A) any person who meets the definition of soil classifier in Section 905.10;
    - B) an Illinois licensed Professional Engineer;
    - C) an employee of a local health department who has 3 years of experience in designing or approving private sewage disposal systems using soil classification information and 6 semester hours of soils-related coursework;
    - D) an employee of a local health department with 5 years of experience reviewing the design and approving private sewage disposal systems using soil classification information under the direct supervision of those persons listed in subsection (a)(2)(A), (B) or (C).
  - 3) If conflicting soils investigation information is provided about a given site, a third Soil Classifier may be requested to provide additional information or help to resolve the conflict. A National Resources Conservation Service (NRCS) Soil Scientist who is also a Soil Classifier may be contacted for technical information or interpretation.
- b) Percolation Tests
- 1) Performance of Percolation Tests. At least 3 separate percolation tests, a minimum of 50 feet apart, shall be performed at the site of each proposed subsurface seepage system.
  - 2) Procedure for Performing Percolation Tests. Percolation tests shall be performed in accordance with the procedure outlined in Appendix A, Illustration G. Alternate procedures for performing percolation tests may be submitted to the Department for review. If determined to be as stringent as that described in Appendix A, Illustration G, the alternate procedure will be approved.
  - 3) The Department or its agent may choose not to accept percolation data results and may require a soil investigation if soils information, permits for private sewage disposal systems in proximity to the proposed site, direct observation or other information shows conditions that will have an impact on the design, construction, installation, modification or performance of the private sewage disposal system.

77 ILLINOIS ADMINISTRATIVE CODE 905  
OCTOBER 2013

(Source: Amended at 37 Ill. Reg. 14994, effective August 28, 2013)

**Section 905.60 Subsurface Seepage System Construction Requirements**

- a) Seepage Field Requirements – Gravel, Gravelless and Chamber Systems. Subsurface seepage fields shall be designed and constructed in accordance with Appendix A, Illustrations H, I and J and the following:
- 1) All subsurface seepage systems using soils information for sizing shall use the soil suitability table in Appendix A, Illustration M to determine the size requirements of the subsurface seepage system. The least permeable soil layer between the top of the gravel or gravelless pipe or chamber system and 2 feet below the bottom of the trench shall be used to determine the size of the subsurface seepage system. For mound or at-grade systems, the least permeable soil layer in the upper 2 feet of the soil shall be used to determine system size.
  - 2) The bottom of the subsurface seepage field, each trench and its distribution line shall be level. Level for this Part shall mean plus or minus ½ inch in any direction over the entire area of the subsurface seepage system.
  - 3) There shall be a minimum of 6 inches and a maximum of 24 inches of earth backfill over the bedding materials, gravelless pipe or chamber system.
  - 4) There shall be a minimum of 5 feet of undisturbed earth between the septic tank and the nearest trench.
  - 5) If precipitation falls onto the excavation and evidence of soil washing into the excavation of the subsurface seepage system exists, the damaged portion of the seepage system shall be reconstructed to comply with this Section.
  - 6) The top of the gravel, gravelless pipe, or chamber system in the subsurface seepage field shall be at least one inch below the invert of the outlet pipe from the septic tank or distribution box in a gravity flow system.
  - 7) Site Evaluation for Subsurface Seepage Systems. Subsurface seepage systems receiving septic tank effluent shall have at least 2 feet of vertical separation distance between the bottom of the subsurface seepage system and the top of the limiting layer. For soils in Design Group I-VI or with a loading rate of greater than 0.62 gallons per day per square foot, there shall be at least a vertical separation distance of 3 feet between the bottom of the subsurface seepage system and the top of the limiting layer. When the limiting layer is the estimated seasonal high water table, artificial drains, which are designed to lower the estimated seasonal high water table, may be installed to achieve the specified vertical separation

distances.

- 8) Sizing of a Seepage System in Fill Soil
  - A) The least permeable soil layer between the top of the gravel, gravelless pipe or chamber system and 2 feet below the bottom of the trench shall be used to determine the size of the subsurface seepage system.
  - B) The use of fill for installing subsurface seepage systems shall not be approved for lots platted after March 15, 1996.
  - C) Fill soils may be used to cover a private sewage disposal system, provided that no part of the system is located in the fill and the fill material is at least equal to or better than the original soil or meets the requirements in subsection (a)(9).
  
- 9) Soil Criteria for Use of Fill in Subsurface Seepage Systems
  - A) Soils to be used for fill shall be identified by a soil classifier or licensed Professional Engineer and a report submitted to the Department or local authority. The report shall contain specific information on the fill soil, including location, depth, permeability, and texture. Soils that can be used as fill are those identified in Appendix A, Illustration M as 2A, 2B, 2K, 3A, 3B, 3C, 3K, 3L, 4B, 4D and 4K (Design Group II, III and IV).
  - B) In addition to the requirements in subsection (a)(9)(A), fill soil shall not contain extraneous material such as tires, concrete, brick, reinforcing bar, demolition material, etc.
  - C) All of the following conditions shall be met for a subsurface seepage system to be installed in fill.
    - i) Satisfactory original soil shall be at least 3 feet above bedrock.
    - ii) A maximum of 2 feet of fill soil shall be used.
    - iii) Fill shall not be placed on original soil with a slope greater than 10%.
    - iv) The fill shall be placed at the site so that a minimum of compaction occurs, and the fill shall be allowed to settle undisturbed for a period of at least 12 months. Soils in Design Group II, when used for fill, shall not be required to

settle for a period of at least 12 months.

- v) After the fill has been settled, a percolation test shall be conducted in accordance with the procedure outlined in Appendix A, Illustration G and a percolation rate of not greater than 270 minutes/6 inch fall or less than 60 minutes/6 inch fall shall be achieved.

10) Site Preparation for Use of Fill Soil

- A) Excess vegetation shall be cut and removed. The site shall be plowed with a mold board plow 7 to 8 inches deep with the plowing done perpendicular to the slope. It shall not be done with the furrow running up and down the slope. Chisel plowing may be used in place of mold board. Roto-tilling is prohibited.
- B) Once the site is plowed, all traffic shall be kept off the site. The fill material can be deposited on the top with a backhoe or pushed on from the side, preferably the upslope side, using a track type tractor, keeping 6 inches of fill beneath the tracks. At no time shall ruts be made in the plowed area. The fill shall be placed immediately after site preparation to avoid the possibility of precipitation falling on the plowed area.
- C) Traffic on the downslope side of the fill area shall be minimal to reduce compaction. All work shall be performed from the ends and upslope side. Compaction of the natural soil downslope will reduce the lateral movement of the effluent.
- D) The fill shall not be placed on frozen ground or when the soil is wet. Moisture content of the soil is very important when filling. Site preparation shall not take place when the soil is too wet. To check moisture content, a soil sample may be taken from the plow layer (7 to 8 inches) and rolled between the palms of the hands. If the soil rolls into a ribbon, it is too wet to prepare. If the soil crumbles, site preparation can then proceed.

b) Gravel Seepage Field Requirements

- 1) Bedding Material. The bedding material shall be clean gravel or clean stone that is free of mud, silt, or clay, with particle size ranging from  $\frac{3}{4}$  inch minimum to 4 inches maximum. The bedding material shall extend the full width of the trench and to a depth of at least 6 inches below the bottom of the distribution line. The bedding material shall extend at least 2 inches above the top of the distribution line.

77 ILLINOIS ADMINISTRATIVE CODE 905  
OCTOBER 2013

- 2) **Distribution Lines.** Distribution lines shall be constructed of materials as approved in Section 905.20(f). The lines shall be perforated or open-joint tile. Where open joint tile is used, the tile sections shall be spaced not less than ¼ inch or more than ½ inch apart. Perforated piping with the exception of 8-inch or 10-inch gravelless seepage beds shall have ½- to ¾-inch diameter openings on 3- to 5-inch centers with a minimum of 2 rows. The openings in the pipe shall be placed downward.
  - 3) **Separation Material.** Bedding materials shall be covered by straw, newspaper, untreated building paper, geotextile fabric or other permeable or biodegradable material to support the backfill as the laying of the distribution line proceeds. Tar paper, plastic, or other impervious material shall not be used between the bedding material and the earth backfill.
  - 4) The ends of a gravel seepage field shall be looped except in serial distribution systems.
- c) **Gravelless Seepage Field Requirements.** In addition to Section 905.20(f), 8-inch or 10-inch gravelless seepage systems shall comply with the following specifications:
- 1) 8-inch and 10-inch inside diameter (I.D.) corrugated polyethylene tubing shall meet the requirements of ASTM F667-06, Standard Specification for Large Diameter Corrugated Polyethylene Tubing with the following exceptions:
    - A) Perforations shall be uniformly spaced along the length of the tubing as follows: 2 rows of holes ⅜ inch in diameter for 8-inch tubing and ½ inch in diameter for 10-inch tubing, located 120° to 140° apart along the bottom half of the tubing, each row 60° to 70° up from the bottom center line. The perforations shall be staggered so that there is at least one hole in each corrugation.
    - B) The pipe shall be marked to indicate the top of the pipe.
  - 2) All gravelless drainfield pipe shall be encased at the point of manufacture with a filter wrap having the following characteristics:

Physical Properties	Minimum Value
Grab Strength, lbs. (ASTM D4632)	
Machine Direction	19
Traverse Direction	11
Burst strength, psi (ASTM D3786-09)	26
Air Permeability, cfm per sq. ft. (ASTM D737-08)	500

77 ILLINOIS ADMINISTRATIVE CODE 905  
OCTOBER 2013

Particle Size Distribution (ASTM F662-86)  
Polyethylene particles in water and alcohol  
solution, coulter counter analysis, single pass:

Particle Size (Microns)	% Retained
70	80
60	68
50	56
40	40
30	22
20	5

- 3) 8-inch or 10-inch gravelless seepage trenches shall comply with the following Illustrations in Appendix A unless otherwise stated in this Part:
  - A) Illustration D
  - B) Illustration H, Exhibit B
  - C) Illustration I, Exhibit C
  - D) Illustration I, Exhibit D
  - E) Illustration J, Exhibit C
  - F) Illustration J, Exhibit D
  - G) Illustration K, Exhibits E through H
  - H) Illustration M, Exhibit A
- 4) Bedding Material. 8-inch and 10-inch gravelless seepage systems or chamber systems may be bedded with material excavated to construct the system. The backfill material shall not contain large clods of earth, demolition material or other extraneous material.
- 5) Separation Material. No straw, newspaper or untreated building paper shall be placed between the gravelless seepage system or chamber system and the earth backfill.
- 6) Bending. 8-inch and 10-inch gravelless pipe shall not be bent around corners on a radius of less than 5 feet. If a sharper radius is required, a tee shall be used.

77 ILLINOIS ADMINISTRATIVE CODE 905  
OCTOBER 2013

- 7) Gravelless seepage systems or chamber systems are not required to be looped. Gravelless seepage systems or chamber systems that are not looped shall be capped on the end.
- d) Serial Distribution. Serial distribution shall be used in areas where the slope of the terrain prohibits the installation of conventional subsurface seepage systems. The following criteria shall be used in the design and construction of a serial distribution system (see Appendix A, Illustration K):
- 1) The bottom of each trench and its distribution line shall be level.
  - 2) There shall be a minimum of 6 inches of earth backfill over the bedding material or chamber system or the gravelless pipe in the trenches.
  - 3) The trench shall follow the ground surface contours so that variation in trench depth will be minimized.
  - 4) There shall be a minimum of 5 feet of undisturbed earth between the septic tank and the nearest trench.
  - 5) Adjacent trenches shall be connected with a relief line or a drop box arranged so that each trench is completely filled to the full depth of the gravel or gravelless pipe or chamber system before effluent flows to the succeeding trench.
  - 6) The relief lines connecting the trenches shall have watertight joints and direct connections to the distribution lines in adjacent trenches. Tight joint T's and 45° ells, or a drop box arrangement shall be used to connect adjacent trenches.
  - 7) Where the relief pipe trench connects with the higher trench, it shall not be deeper than the top of the gravel or gravelless pipe or chamber system in the higher trench. Relief lines shall rest on undisturbed earth and the backfill shall be carefully tamped.
  - 8) The invert of the first relief line shall be at least one inch lower than the invert of the septic tank or aerobic treatment plant outlet. (See Appendix A, Illustration K.)
  - 9) All other construction features of the serial distribution field shall comply with subsections (a) through (d).
- e) Seepage Beds. The total bottom area of the seepage bed shall be 1½ times the area specified in Appendix A, Illustration H, Exhibit A or Illustration M, Exhibit A. Construction features shall conform to subsections (a) and (b). Distribution lines shall be spaced no farther than 6 feet center to center and shall be equally



spaced. Lines adjacent to the bed sidewalls shall be 18 inches from the bed sidewall. (See Appendix A, Illustration L.) Seepage beds shall be constructed so that construction equipment does not drive over the bottom of the bed.

- f) Chamber Systems. Chamber systems shall be sized and installed in accordance with the following:
- 1) Center-to-center spacing for chamber systems shall be in compliance with Appendix A, Illustration I, Exhibit D.
  - 2) Chamber systems shall be sized in accordance with Appendix A, Illustration I, Exhibit E.
  - 3) Chamber systems shall be designed to support all weight of earth backfill without collapsing.
  - 4) Chamber systems shall be designed to prevent earth backfill from restricting flow within the chamber.

g) Subsurface Drip Irrigation Systems. Subsurface drip irrigation systems shall be designed, installed and maintained in accordance with the following:

- 1) The drip irrigation system shall be designed, installed and operated as a subsurface seepage system, and no portion of the drip irrigation system shall have a surface discharge.

A) Pre-treatment

- i) The drip irrigation system shall be preceded by a pre-treatment process designed to reduce the CBOD<sub>5</sub> (carbonaceous 5-day biochemical oxygen demand) to a maximum concentration of 25 mg/L and total suspended solids to a maximum concentration of 30 mg/L. Drip irrigation systems shall not be installed following a septic tank without any pre-treatment process capable of meeting this Part's requirements.
- ii) The total flow from the property plus the backwash water from the drip irrigation system shall not exceed the treatment capacity of the pre-treatment device.
- iii) The installation contractor, designer or homeowner, in consultation with the manufacturer or the manufacturer's representative, shall assure that the pre-treatment process meets the requirements of this Part.

**B) Dosing Tank**

- i) A minimum liquid capacity of 1,000 gallons shall be provided below the inlet in the dosing tank for a residential or non-residential site.
- ii) For homes larger than three bedrooms and non-residential systems with a daily design flow greater than 667 gallons/day, a dosing tank with a minimum capacity of 1.5 days design flow shall be provided.

**C) Dosing Pump**

- i) A high head/low volume pump shall be used.
- ii) The pump shall be sized based upon the design flow rate of the drip irrigation field, which shall be based on the number of emitters times the flow rate of each emitter in gallons per minute.
- iii) The minimum head requirement of the pump shall be based upon the pressure requirements for the operation and flushing of the drip field plus the total static and friction head requirements of the supply lines and manifolds.
- iv) Pump specifications used for drip irrigation systems shall be provided by the pump manufacturer.
- v) The installation contractor, designer or homeowner, in consultation with the manufacturer or the manufacturer's representative, shall assure that the pump used is in compliance with this Part.

**D) Time Dosing**

- i) Drip irrigation systems shall be provided with a timer to activate the dosing pump equally throughout a 24-hour period.
- ii) Systems shall be dosed a minimum of 6 equal doses over a 24-hour period and shall be capable of delivering the maximum daily design flow to the drip irrigation system in a 24-hour period. More frequent doses of 8 to 24 equal doses over a 24-hour period are recommended and shall be required in soils that have a loading rate of less than 0.5 gallons/square foot/day.

- iii) The dosing frequency shall be such that the soil surrounding the drip irrigation system does not become saturated.
- iv) The dosing specifications shall be provided by the drip irrigation manufacturer or the manufacturer's representative in accordance with this Part.

E) Effluent Filtration

- i) Wastewater effluent shall be filtered to the drip tubing manufacturer's specifications to ensure proper operation of the distribution system.
- ii) The effluent filtration device shall be easily accessible for maintenance and inspection.

F) Drip Distribution System

- i) The drip distribution tubing manufacturer or the manufacturer's representative shall provide written specifications for all components used in conjunction with the drip irrigation system.
- ii) The manufacturer or the manufacturer's representative shall assure that all manufacturer specifications for the drip irrigation system are in compliance with this Part.
- iii) The manufacturer shall incorporate measures to prevent root intrusion into the emitters.

G) Drip Emitters and Flow Rates

- i) The manufacturer of the drip tubing shall specify the number of drip emitters per lineal foot and the flow rates through each emitter for different pressures.
- ii) The installation contractor or homeowner, in consultation with the manufacturer or the manufacturer's representative, shall assure that the number of emitters to be used in a drip irrigation system and the types of emitters used, flows and flow rates into the soil comply with all of the manufacturer's specifications and requirements and with this Part.

**H) Absorption Field Sizing**

- i) A soil investigation shall be conducted in accordance with Section 905.55(a).
- ii) The soil loading rate (gallons/square foot/day) shall be based upon the least permeable soil condition encountered within 24 inches below the proposed depth of the drip irrigation tubing.
- iii) The system size shall be based upon Appendix A, Illustration M, Exhibits A and B.

**D) Drip Tubing Installation and Configuration**

- i) The drip tubing shall be installed in the natural soil using installation equipment and procedures specified by the manufacturer.
- ii) Drip irrigation tubing shall be installed at a depth of 6 inches to 12 inches below the final graded surface.
- iii) Drip irrigation tubing shall be installed on a minimum of 2-foot centers.
- iv) When the drip irrigation piping is installed on slopes exceeding 20%, the spacing between the drip irrigation piping shall be 3 feet or greater.
- v) The drip irrigation system shall be configured so that the length of the area of the drip irrigation tubing system is at least two times its width. If this is not possible, the drip irrigation tubing trench separation distance shall be doubled.
- vi) The length of individual drip distribution tubing shall not exceed the manufacturer's specifications and shall be installed at a uniform depth that follows the contour of the site.
- vii) The drip irrigation tubing shall be installed a minimum of 12 inches above a limiting layer.

**J) Considerations to Prevent Freezing**

- i) The distribution and return manifolds shall be installed to drain back to the pre-treatment tank after the field has been dosed.
  - ii) If the elevations of the pre-treatment tank and dosing tank do not allow gravity flow to the pre-treatment tank, the lines shall be installed to drain back to the dosing tank.
  - iii) All piping and components shall be installed to allow water to drain back to the pre-treatment tank or dosing tank.
  - iv) To allow for drain back, a check valve shall not be installed in the supply and return lines.
- K) **Fill Soils**  
Fill soils may be used in accordance with subsection (a), except that the soil surface shall not be plowed.
- L) **Pressure Requirements**
- i) The manufacturer of the drip tubing shall specify the operating pressure requirements of the drip irrigation system and provide the specifications of any pressure regulator that may be required with the drip irrigation system.
  - ii) A pressure gauge shall be provided or a method of connecting a pressure gauge shall be provided on the distal end of the drip irrigation system to ensure that field pressure can be checked during inspection, evaluation and maintenance. The installation contractor or manufacturer shall ensure that the irrigation system is operating at the required specifications.
- M) **Flush Valves**
- i) An automatic or manual flush valve shall be provided on the filter and drip distribution system to allow for periodic flushing of both the drip distribution system and the filter.
  - ii) The drip distribution system manufacturer shall provide the specifications for the flush valves that are acceptable to use with the system. The manufacturer shall also provide specifications on the number of flush valves to be used and their location, with specifications about how this is to be

determined and the backwash velocity required to clean the drip tubing piping.

iii) A chemical injection port shall be installed to facilitate cleaning and flushing the drip distribution system.

iv) Backwash water shall be directed into the building sewer at the inlet end of the pre-treatment system.

N) Air Relief

i) The manufacturer of the drip tubing shall specify the air relief requirements of the drip distribution system and provide the specifications of any air relief devices that may be required with the drip irrigation system to ensure that the distribution piping can drain back to the dosing chamber when the system is not pressurized.

ii) The air relief device shall be installed at the highest point of the feed and return manifolds.

O) Alarm

i) An audible and visual alarm shall be provided to warn of a high water condition in the dosing tank.

ii) The alarm shall be on a separate dedicated circuit.

iii) The alarm control device shall be a sealed float or diaphragm switch and shall be located to activate 2 to 3 inches above the pump turn-on level or siphon activation level.

iv) The alarm shall be located outside of the structure served by the system and shall be provided with an electrical disconnect that is located within sight of and not more than 50 feet away from the device.

v) If an alarm is being used by another component within the private sewage disposal system, is compliant with subsections (g)(1)(O)(i) through (iv), and is able to connect additional devices, it may be used without the need for an additional alarm.

P) Access

- i) Access openings to the pre-treatment system, effluent filtration system, and dosing tanks shall have a minimum inside dimension of 18 inches, shall be watertight and shall extend to 3 inches or more above the ground surface.
  - ii) Access openings to all other system components shall be large enough to allow easy access from the ground surface.
- Q) Maintenance
- i) The manufacturer shall provide specifications for the maintenance of all components within the drip irrigation system.
  - ii) The manufacturer shall provide a maintenance plan to ensure that maintenance is conducted as required to achieve the proper function of the system.
- 2) The installation contractor or manufacturer shall provide the following information to the owner of the system:
- A) An operation manual;
  - B) The maintenance plan for the drip irrigation system;
  - C) The manufacturer of the components and a description of the function of the components;
  - D) The service contract information;
  - E) A troubleshooting repair guide;
  - F) A list of safety concerns;
  - G) Manufacturer's cut sheets for all electrical and mechanical components; and
  - H) An as-built drawing of the system.

(Source: Amended at 37 Ill. Reg. 14994, effective August 28, 2013)

**Section 905.70 Buried Sand Filters**

- a) General. Buried sand filters may be used, provided that the effluent is discharged in accordance with the requirements of Section 905.110.
- b) Size. Buried sand filters shall be sized as follows:
  - 1) Residential. The sand filter surface area for residential property shall be 200 square feet per bedroom. Where a sand filter is used in conjunction with an approved aerobic treatment plant, the surface area of the sand filter may be reduced by 50 percent.
  - 2) Non-Residential. All of the following shall be met when a buried sand filter is to be installed on non-residential property.
    - A) The surface area of the sand filter shall be designed for one square foot per gallon per day for waste with an influent Biochemical Oxygen Demand (BOD) not to exceed 300 parts per million (ppm).
    - B) A sand filter with flows of 801 gallons or more per day shall have the influent distributed into the sand filter by a dosing system designed according to subsection (1). The sand filter shall be dosed 4 times per day with equal flows not to exceed the design capacity of the filter.
- c) A single individual sand filter shall be used to treat flows from a wastewater source. Splitting flows prior to treatment or the use of multiple sand filters shall be prohibited unless subsurface disposal of the effluent is used. Where allowed, splitting of flows shall be done by pumps.
- d) Minimum Size. The minimum size buried sand filter shall be designed to treat at least 100 gallons of waste per day.
- e) Sand Filter Media. The depth of filter media shall be a minimum of 24 inches. The sand shall have an effective size of 0.5 to 2.0 millimeters, and a uniformity coefficient of less than 3.5. It shall be clean and free of clay and silt.
- f) Alternate Media. Other filter media may be used in a subsurface filter provided that they meet the criteria of subsection (e) and comply with the following requirements:
  - 1) Are chemically and biologically inert;
  - 2) Will support biological growth; and
  - 3) Have a hardness equivalent to, or greater than, that of sand.



77 ILLINOIS ADMINISTRATIVE CODE 905  
OCTOBER 2013

- g) **Filter Media Cover.** The filter media shall be covered with a minimum of 10 inches of clean coarse gravel or clean stone that is free of mud, silt or clay, ranging in size from  $\frac{3}{4}$  to  $2\frac{1}{2}$  inches in diameter. The gravel or stone shall be covered with straw, untreated building paper, or other permeable material prior to backfilling. A minimum of 12 inches of earth cover shall be provided. (See Appendix A, Illustration N.)
- h) **Distribution and Collection Lines.** The distribution and collection lines shall conform to the requirements for distribution lines in Section 905.60(b)(2). The distribution lines shall be level, shall be located 18 inches from sidewalls, and shall be spaced on 3-foot centers. There shall be solid pipe to the filter media. The collection lines shall have a slope of 6 inches per 100 feet, and one collection line shall be provided for each 10 feet of width or fraction of 10 feet, and shall be equally spaced. The upper end of the collection line shall be capped.
- i) **Bedding Material.** The bedding material for the collection lines shall be placed as shown in Appendix A, Illustration N, and shall be clean gravel or clean stone that is free of mud, silt or clay. The coarse gravel shall range in size from  $\frac{3}{4}$  to  $2\frac{1}{2}$  inches in diameter, and pea gravel shall range from  $\frac{1}{8}$  to  $\frac{3}{8}$  inches in diameter. A minimum of 2 inches of coarse gravel shall be placed on the excavation before placement of the collection lines.
- j) **Venting.** A minimum of one vent shall be placed on the downstream end of the distribution lines as shown in Appendix A, Illustration N. These vents shall be placed as close as possible to the corners on the downstream distribution lines. The vents shall extend above the ground surface and be screened with  $\frac{1}{4}$ - inch mesh screen or equivalent.
- k) **Drainage.** Surface drainage shall be directed away from the filter. If conditions prohibit gravity drainage of the filter effluent, a pumping chamber shall be installed. The chamber shall be constructed of a watertight, non-corrosive material and shall be provided with a removable lid, which will serve as an access for inspection, cleaning and general maintenance. An access port or extension collar shall extend at least 6 inches above the ground surface, and the access shall have a minimum dimension of 12 inches. The chamber shall have sufficient depth and the pump controls shall be set in a manner to allow for complete drainage of the filter to eliminate any ponding of effluent within the filter. (See Section 905.125, Pumps, Pumping/Dosing Chambers, and Ancillary Equipment.)
- l) **Distribution of Effluent.** Buried sand filters designed to treat non-residential property with flows of 801 gallons or more per day shall have the effluent distributed into the sand filter by pumping. The pumps, pumping chamber and ancillary equipment shall comply with Section 905.125 and the following:
  - 1) **Dosing Volume.** The dosing volume is the amount of liquid pumped or

77 ILLINOIS ADMINISTRATIVE CODE 905  
OCTOBER 2013

siphoned during each cycle minus the amount that drains back from the sand filter after each dose.

- 2) Pump Selection. The pump shall be a submersible pump designed for corrosive liquids.
- 3) Siphons. Siphons can be designed where elevation exists between the sand filter and the siphon chamber. However, the siphon shall be designed to deliver the same flow rate at the same head at the distribution system as a pump system. The distribution system consisting of manifold and laterals shall be designed so that it will drain after each siphon. This shall be accomplished by placing the manifold above the laterals.

(Source: Amended at 37 Ill. Reg. 14994, effective August 28, 2013)

**Section 905.80 Re-circulating Sand Filter**

- a) General. The re-circulating sand filter system (Appendix A, Illustration O) consists of a septic tank, recirculation tank, open sand filter and flow splitter. It may be used provided that the effluent is discharged in accordance with the requirements of Section 905.110.
- b) Septic Tank. The septic tank shall be sized and installed as described in Section 905.40.
- c) Re-circulation Tank. The re-circulation tank volume shall be 500 gallons, and the tank shall be equivalent in strength and materials to the septic tank as provided in Section 905.40. No baffles are necessary. An access manhole, as described in Section 905.40(b)(7), shall be provided for pump maintenance or replacement.
- d) Sand Filter. The sand filter shall be sized at one square foot of filter surface for every 3 gallons per day of domestic sewage flow. Appendix A, Illustration P has a size chart for residences based on numbers of bedrooms. Unless otherwise stated in Appendix A, Illustration P, the sizes shown are required. The filter media shall comply with requirements of Section 905.70(e) and (f) and shall be 30 inches in depth.
- e) Bedding Material. The bedding material for the collection lines shall be the same as that in a buried sand filter. The coarse gravel shall be  $\frac{3}{4}$  to  $2\frac{1}{2}$  inch diameter, and the pea gravel shall be from  $\frac{1}{8}$  to  $\frac{3}{8}$  inches diameter. A minimum of 2 inches of coarse gravel shall be placed on the excavation prior to placement of collection lines.
- f) Distribution and Collection Lines. The collection lines shall be constructed of materials as approved in Section 905.20(f) and shall be 4 inches inside diameter perforated piping laid with perforations facing downward. The distribution piping shall have an inside diameter of  $1\frac{1}{2}$  inches. The perforated pipe shall have  $\frac{1}{2}$  to  $\frac{3}{4}$  inch diameter openings on 3-inch to 5-inch centers with 2 rows at  $120^\circ$  from each other. Distribution piping shall be spaced on 3-foot centers and shall be located a minimum of  $1\frac{1}{2}$  feet from sidewalls.
- g) Pumps. The pump shall be a submersible pump designed for corrosive liquids and shall have a capacity of 15 to 25 gallons per minute at the 10-foot total dynamic head (TDH). The pump shall be controlled by a time clock that can be set to activate the pump at one hour or longer intervals. Pump shut-off shall be controlled by a low level float switch that allows the entire contents of the re-circulation tank to be pumped during each pump cycle. A high level float switch shall be provided that energizes a visible and audible alarm to indicate pump failure or malfunction. (See Appendix A, Illustration Q.)
- h) Flow Splitter. The flow splitter shall be designed so that re-circulation rates can

77 ILLINOIS ADMINISTRATIVE CODE 905  
OCTOBER 2013

be controlled between no re-circulation and a 5:1 re-circulation ratio. An example of one type of splitter is shown in Appendix A, Illustration O.

(Source: Amended at 37 Ill. Reg. 14994, effective August 28, 2013)

### **Section 905.90 Waste Stabilization Ponds**

General. Waste stabilization ponds may be used if designed and constructed in accordance with the following criteria and provided that the effluent is discharged in accordance with the requirements of Section 905.110 (see Appendix A, Illustration R as an illustration of these requirements). A septic tank sized according to Appendix A, Illustration F or an aerobic treatment plant shall precede a waste stabilization pond.

- a) Location. A waste stabilization pond shall be located as distant as practical from residences, but in no case closer than the distances shown in Appendix A, Illustration D, and in an area where trees will not interfere with sunlight on the surface.
- b) Dimensions. Ponds shall have a length not exceeding 3 times the width.
- c) Capacity. When domestic sewage from a septic tank is to be discharged to the waste stabilization pond, the capacity of the pond shall be equivalent to 60 times the average daily flow. When preceded by a Class II aerobic treatment plant, the capacity of the pond shall be equivalent to 18 times the average daily flow.
- d) Depth. The wastewater depth for a waste stabilization pond shall be uniform and 3 feet to 5 feet.
- e) Freeboard. A minimum freeboard of 2 feet shall be provided.
- f) Embankments. Embankments shall be constructed of impermeable materials and shall be compacted. Embankment slopes shall be in one to 2 (vertical to horizontal) below the water line and one to 3 or flatter above the water line. The top width of the embankment shall be a minimum of 2 feet. Embankments shall be seeded or rip-rapped from the outside toe to the high water line. Perennial, low growing, spreading grasses that withstand erosion and can be kept mowed are most satisfactory for seeding of embankments.
- g) Inlet. The inlet line shall be placed 12 to 24 inches above the bottom of the pond at a point opposite the overflow structure and shall be supported at no greater than 10-foot intervals along its length. It shall discharge at least 10 feet from the water's edge. The inlet line shall be sloped in accordance with Section 905.20(g).
- h) Outlet. The outlet structure shall be designed to prevent the discharge of floating solids. This shall be accomplished through baffling. The baffle shall consist of a sanitary T or 90° elbow. If the 90° elbow is used, a ¼ inch hole shall be drilled into the top of the elbow to provide an air break. The outlet baffle shall extend 12 inches below the invert of the overflow. The outlet baffle shall be 3 to 5 feet from the embankment.
- i) Bottom. The bottom of the waste stabilization pond shall be cleared and leveled

77 ILLINOIS ADMINISTRATIVE CODE 905  
OCTOBER 2013

to the required elevation and shall be lined with an impermeable natural or man-made material. The pond shall be kept free of vegetation that would grow to or above the water surface.

- j) Drainage. All surface water shall be diverted away from the waste stabilization pond.

(Source: Amended at 37 Ill. Reg. 14994, effective August 28, 2013)

**Section 905.95 Illinois Raised Filter Beds**

- a) Illinois raised filter bed disposal systems shall have a filter loading rate of 4 gallons per square foot per day for residential systems of up to 1,500 GPD flows. Non-residential systems of any size or residential systems in excess of 1,500 GPD shall use a filter loading rate of 2.5 gallons per square foot per day. The system shall be designed in accordance with Appendix A, Illustration X, Exhibits A through E.
- b) An aeration batch treatment system that has been approved by NSF in accordance with NSF Standard 40 shall be used. The aeration tank volume shall hold at least 2 times the average daily wastewater flow for residential use (including the use of a garbage disposal). Non-residential systems shall have a tank volume size of 3 times the daily wastewater flow. Multiple tanks shall be used to achieve the volume required. Multiple tanks require connection at the bottom of each tank for flow equalization.
- c) Filter beds shall not exceed 600 square feet. If a larger area is needed, multiple beds shall be used, separated by a minimum distance of 15 feet, using a common mantle. The filter beds can be placed at any point on the mantle to accommodate existing ground contours.
- d) The filter length shall not exceed 3 times the width.
- e) The sand filter media shall have an effective size of 0.5 to 2.0 millimeters, a uniformity coefficient of less than 3.5, and a 30-inch depth.
- f) The mantle shall be sized in accordance with the formula  $A = QT/25$ , where A = Mantle Area, Q = Quantity of wastewater per day, and T = Percolation time of the original soil in minutes per inch. (See Appendix A, Illustration X, Exhibit E to convert soil investigation information to T (percolation time).)
- g) The mantle shall be at least equal to the area of the filter bed. The mantle shall not be designed for percolation rates that exceed 120 minutes per inch.
- h) The mantle area is to be cut into original soil to a depth of 6 inches and back-filled with 12 inches of torpedo sand that is graded as FA1-FA8 in accordance with Standard Specifications for Road and Bridge Construction (Illinois Department of Transportation).
- i) The slope of the bottom of the mantle shall be level, plus or minus one inch. The slope of the earth sidewalls of the filter shall be a maximum of 3 feet horizontal to one foot vertical.
- j) The mantle area shall be at least 12 inches deep. If the maximum high groundwater table is less than 6 inches from the bottom of the filter bed,

77 ILLINOIS ADMINISTRATIVE CODE 905  
OCTOBER 2013

additional torpedo sand shall be used to increase the isolation distance between the bottom of the filter bed and the high groundwater table to at least 6 inches. Other separation distances (e.g., well, property line) shall be measured from the toe of the filter bed.

- k) The distribution piping (4-inch perforated pipe) shall be placed level to 15-inch centers in 12 inches of  $\frac{3}{4}$ -inch stone.
- l) Sod shall be placed over the filter beds and mantle.

(Source: Amended at 37 Ill. Reg. 14994, effective August 28, 2013)



**Section 905.96 Peat Filter Systems**

- a) General. Peat filter systems shall be preceded by a septic tank, Imhoff tank, or aeration system meeting the requirements of Section 905.30, 905.40 or 905.100, and the effluent from the system shall be discharged into a subsurface system approved in Section 905.60. The size of the subsurface system may be reduced by  $\frac{1}{3}$ , provided that the effluent quality meets the requirements of Section 905.110(d)(1)(A) and (B).
- b) Design. The system shall be sized in accordance with the manufacturer's requirements as approved by the Department.
- c) Approval of Systems. Manufacturers of peat systems shall present information to the Department documenting that effluent from their system meets the requirements of subsection (a). The information shall be in the form of independent test data or reports. The Department will grant approval and maintain a list of those systems meeting the requirements of this subsection and only approved systems may be installed.

(Source: Amended at 37 Ill. Reg. 14994, effective August 28, 2013)

**Section 905.100 Aerobic Treatment Plants and NSF International/ANSI Standard 40 Wastewater Treatment Systems**

- a) **General.** Aerobic treatment plants and NSF International/ANSI Standard 40 wastewater treatment systems shall be tested and listed by NSF International or a laboratory approved by ANSI and certified compliant with the International Organization for Standardization (ISO)/International Electrotechnical Commission (IEC) Guide 65 to determine compliance with the requirements of NSF International/ANSI Standard 40, Residential Wastewater Treatment Systems. To assure compliance with certification requirements and the Act and this Part, the Department will obtain and retain from NSF International a complete list of approved systems, approved components and approved component parts for each NSF International/ANSI Standard 40 wastewater treatment system installed or currently existing within the State. Until the Department receives the NSF approval information, the system shall not be considered approved in accordance with the Act and this Part. Standard 40 is a standard that covers an organized and coordinated system of components that functions to treat wastewater generated by individual residences. This Part shall allow approved aerobic treatment plants and NSF International/ANSI Standard 40 wastewater treatment systems to serve residential property that is occupied on a year-round or full-time basis. Aerobic treatment plants shall not be used to serve residential property that is used as a seasonal, weekend or part-time residence.
- b) **Class II Effluent.** Aerobic treatment systems listed by NSF International or a laboratory approved by ANSI to determine compliance with NSF International/ANSI Standard 40 for Class II effluent shall discharge to one of the following:
- 1) A subsurface seepage system designed and constructed in accordance with the requirements of Section 905.60.
  - 2) A sand filter designed and constructed in accordance with the requirements of Section 905.70 or 905.80.
  - 3) A waste stabilization pond designed and constructed in accordance with the requirements of Section 905.90.
- c) **Class I Effluent.** NSF International/ANSI Standard 40 wastewater treatment systems listed by NSF International or a laboratory approved by ANSI to determine compliance with NSF International/ANSI Standard 40 for Class I effluent shall discharge to one of the following:
- 1) A subsurface seepage field designed and constructed to be at least  $\frac{2}{3}$  the size determined necessary by Section 905.60. The subsurface system shall be installed as shallow as possible while maintaining a minimum of 6 inches of cover. There shall be at least 12 inches between the bottom of

the subsurface seepage system (soil interface) and the shallowest limiting layer.

2) A surface discharge in accordance with Section 905.110.

d) Sizing. Aerobic treatment plants that are listed by NSF International or a laboratory approved by ANSI to determine compliance with NSF International/ANSI Standard 40 as Class I and rated at 500 gallons per day will be allowed for the treatment of sewage from residential property having up to and including 4 bedrooms. Other aerobic treatment plants that are listed by NSF International or a laboratory approved by ANSI to determine compliance with NSF International/ANSI Standard 40 as Class I shall be sized as follows:

Bedrooms	Minimum Rated Treatment Capacity-Gallons
1	400
2	400
3	500
4	500
5	750
6	900
7	1000
8	1200
9	1350
10	1500

e) Installation. All components of aerobic treatment plants shall be installed at the time of the original installation. If this is not possible, a solid end cap shall be securely placed over the end of the discharge line until the system can be completed. This will prevent the discharge of raw sewage to the ground surface.

f) Accessibility for Inspection and Maintenance. The aerobic treatment plants or NSF International/ANSI Standard 40 wastewater treatment systems shall be equipped with one or more grade-level access manholes having a minimum inside dimension of 18 inches that extend to 3 inches or more above the ground surface. The manhole shall be equipped with a lid that is secured in compliance with Section 5.7.2 of NSF International/ANSI Standard 40. These manholes shall be located to permit periodic physical inspection and maintenance of all compartments and component parts. Component parts include submerged bearings, moving parts, tubes, intakes, slots, filters, and other devices.

g) Service. Devices falling within the scope of NSF International/ANSI Standard 40 require periodic maintenance to achieve performance consistent with demonstrated capabilities. Implicit in NSF International/ANSI Standard 40 is the recognition that assured professional service is imperative. NSF International/ANSI Standard 40 and this Part require a 2-year service policy to be

77 ILLINOIS ADMINISTRATIVE CODE 905  
OCTOBER 2013

provided as part of the initial service agreement. (Note: The following initial service policy includes items not included in the NSF International/ANSI Standard 40 service policy.)

- 1) Initial service policy. The private sewage disposal installation contractor, through the manufacturer or the distributor of the aerobic treatment unit, shall furnish a 2-year initial service policy to the purchaser. This policy shall provide for:
  - A) Four inspection/service calls, at least one every 6 months, that include inspection, adjustment and servicing of the mechanical and the applicable component parts to ensure proper function;
  - B) An effluent quality inspection consisting of a visual check for color, turbidity, scum overflow, and an examination for odors;
  - C) Reporting to the owner immediately any improper operation that cannot be corrected at the time of the inspection or service call. This shall be followed by a written report to the owner that includes the date by which the condition will be corrected.
- 2) Continuing service policy. Each manufacturer shall make available for purchase by the owner a continuing service policy with terms equal to the initial service policy.
- 3) Standby parts. The local distributor shall stock standby mechanical and electrical component parts for use when the plant's mechanical or electrical components must be removed from the site for repairs.
- 4) Component parts. The mechanical and electrical component parts shall be guaranteed against any defects in materials and workmanship as warranted.
- 5) Service. Service shall be available within 2 working days following a request.
- 6) Owner's manual. The manufacturer shall provide an owner's manual with each unit. The manual shall include the following information:
  - A) Model numbers;
  - B) Functional description of unit, including a statement of minimum performance requirements as established by test;
  - C) Design and flow diagrams;

77 ILLINOIS ADMINISTRATIVE CODE 905  
OCTOBER 2013

- D) Warranty;
  - E) Replacement policy and service policy;
  - F) Installation instructions;
  - G) Detailed operation and maintenance requirements (including user responsibility, parts and service);
  - H) Rated service flow in GPM (gallons per minute) or GPD (gallons per day);
  - I) Energy source and energy required for proper operation of the plant; and
  - J) Specification of models tested under NSF International/ANSI Standard 40.
- 7) Service label. A clearly visible, permanently attached label or plate giving instructions for obtaining service shall be placed at the audible and visual alarm.
- 8) Responsibility of property owner. The property owner shall be responsible for maintaining and operating the plant in accordance with this Part and the manufacturer's specifications.
- h) Operation. Aerobic treatment plants and NSF International/ANSI Standard 40 wastewater treatment systems shall produce an effluent meeting the physical, chemical and biological requirements of Section 905.110. Under normal operation and, if an electrical or mechanical failure or other performance failure or malfunction occurs, the design and construction of the aerobic treatment plant or NSF International/ANSI Standard 40 wastewater treatment systems shall prevent the discharge of wastewater from any opening that is not part of the designed flow path of the entire treatment process and shall prevent the discharge of wastewater that is not in compliance with Section 905.110.
- i) Maintenance. If a routine service call indicates an electrical, mechanical or performance failure or malfunction or if routine laboratory test results indicate improper treatment, the property owner shall immediately take action to bring the aerobic treatment plant or NSF International/ANSI Standard 40 wastewater treatment systems into compliance with this Part.
- j) Non-residential Use. Aerobic treatment plants and NSF International/ANSI Standard 40 wastewater treatment systems that are listed by NSF International or a laboratory approved by ANSI to determine compliance with NSF International/ANSI Standard 40 as Class I will be considered for use to serve a

77 ILLINOIS ADMINISTRATIVE CODE 905  
OCTOBER 2013

non-residential property, provided that all of the following are met:

- 1) Total daily flows from the wastewater source into the plant are at least 75% of the rated hydraulic capacity and do not exceed the rated hydraulic capacity of the plant.
  - 2) Wastewater influent shall not exceed the manufacturer's design specifications for BOD5 loading as established by NSF International or a laboratory approved by ANSI to determine compliance with NSF International/ANSI Standard 40 during testing of the plant.
  - 3) Hourly flows from the wastewater source into the plant are less than or equal to the treatment capacity of the plant divided by 24. This may require the installation of a flow equalization device.
  - 4) A buried sand filter sized with a surface area equal to 2 gallons per square foot per day and dosed at least once but not more than 4 times per day shall immediately follow the aerobic treatment plant.
- k) **Splitting of Flows. Splitting of flows from a wastewater source or the use of multiple aerobic treatment plants or NSF International/ANSI Standard 40 wastewater treatment systems shall be prohibited unless subsurface disposal of the effluent is used. Where allowed, splitting of flows shall be done by pumps.**
- l) Private sewage disposal installation contractors or homeowners who maintain or service aerobic treatment plants and NSF International/ANSI Standard 40 wastewater treatment systems shall be required to maintain the integrity of the NSF International seal or the seal of a laboratory approved by ANSI to determine compliance with NSF International/ANSI Standard 40. Only component parts approved for use in an individual plant may be used. No design changes or component part changes may be made that will void the NSF International seal or the seal of a laboratory approved by ANSI to determine compliance with NSF International/ANSI Standard 40. Any person who voids the NSF International seal or the seal of a laboratory approved by ANSI to determine compliance with NSF International/ANSI Standard 40 shall be responsible for repairing the plant so it can bear the NSF International seal or the seal of a laboratory approved by ANSI to determine compliance with NSF International/ANSI Standard 40 or shall replace the plant with an approved private sewage disposal system.

(Source: Amended at 37 Ill. Reg. 14994, effective August 28, 2013)

**Section 905.110 Effluent Discharges**

- a) General. Buried sand filters, re-circulation sand filters, waste stabilization ponds, aerobic treatment plants and NSF International/ANSI Standard 40 wastewater treatment systems listed by NSF International/ANSI Standard 40 as Class I effluent (see Section 905.100(a) and (c)) or any Department approved or accepted system may be discharged to any one of the following 3 options:
- 1) A receiving stream, river, lake or pond that provides greater than a 5:1 dilution of the effluent, based on the 7-day, 10-year low flow rate. A discharge within 10 feet of one of these receiving bodies of water shall be considered to be a discharge to the receiving body of water. Discharges greater than 10 feet from the receiving body of water shall comply with subsection (a)(2) or (3). Discharges to a lake or pond shall be limited to 2 discharges per surface acre of water. More than 2 discharges may occur per individual surface acre of water; however, the total number of discharges to total surface acres of water shall not exceed a ratio of 2:1. An example of this is as follows: In a 20-acre lake, several discharges may enter the lake in a 1/2-acre cove; however, the total discharges entering the lake would be limited to 40. Where discharges are not equally distributed around a lake or pond, the Department or local authority shall be consulted to assure that nuisance conditions are not created.
  - 2) A common collector, provided that the collector does not discharge within one mile upstream from a public water supply intake, public bathing beach, or to any public use area. A public use area is any area that is frequently used by the public. Examples of a public use area are playgrounds and picnic areas. Discharges from lots platted (e.g., individual lots, subdivisions, commercial developments) after January 1, 2014 are not eligible to discharge into a common collector.
  - 3) The ground surface, where the discharge points of private sewage disposal systems with surface discharges do not exceed an average of one per acre and the effluent does not pond or create a nuisance condition.
- b) Whenever a subdivision is platted that does not provide private sewage disposal systems in compliance with Section 905.60 or subsection (a) of this Section, then a sewage system in compliance with 35 Ill. Adm. Code 301 shall be provided.
- c) When lots have been platted prior to March 15, 1996, the applicant for plan approval or local authority approval may apply for a variance to this Section in accordance with the provisions of Section 905.20(1).
- d) Effluent Limitations
- 1) Surface discharging private sewage disposal systems shall not exceed the

following effluent standards:

- A) The system shall comply with NSF International/ANSI Standard 40, Section 8.5.2.1.1 for carbonaceous 5-day biochemical oxygen demand (CBOD<sub>5</sub>) and Section 8.5.2.1.2 for total suspended solids (TSS).
  - B) No effluent shall contain settleable solids.
  - C) Color, odor and turbidity shall be reduced to below discernable levels.
  - D) No effluent shall contain floating debris, visible oil, grease, scum or sludge solids.
  - E) Fecal coliform bacteria concentration shall not exceed 400 organisms per 100 ml.
  - F) **Sample Ports.** After January 1, 2014, any surface-discharging system installed, repaired, renovated or replaced shall have a sample port of at least 4 inches in diameter or free-fall discharge of at least 12 inches located after the disinfection component, which extends to 3 inches or more above the ground surface. A sample port is not required if a free-fall discharge is within 200 feet of the disinfection device. The sample cannot be taken from a common collector or drainage tile, but must be taken from a discharge point that discharges only the treated effluent from the surface-discharging private sewage disposal system.
  - G) A surface-discharging system installed after January 1, 2014 shall not discharge to a roadside ditch as stipulated in the Illinois Highway Code [605 ILCS 5/9-123].
- 2) Samples shall be analyzed in accordance with the Standard Methods for the Examination of Water and Wastewater.
- e) Private sewage disposal systems designed to be compliant with subsection (d) can be discharged to a subsurface seepage field designed and constructed to be at least  $\frac{2}{3}$  the size determined necessary by Section 905.60. The subsurface system shall be installed to be as shallow as possible while maintaining a minimum of 6 inches of cover and one foot of separation from the bottom of the trench to the shallowest limiting layer.

(Source: Amended at 37 Ill. Reg. 14994, effective August 28, 2013)



**Section 905.115 NPDES Permit Compliance**

For those surface discharging private sewage disposal systems from which effluent enters into the Waters of the United States that require a general NPDES permit, a permit can be obtained from the US Environmental Protection Agency (USEPA) or the Illinois Environmental Protection Agency (IEPA). Systems permitted under the general NPDES permit shall be in compliance with the terms and conditions of the general NPDES permit. A surface discharging private sewage disposal system that is required to be permitted under an individual NPDES permit shall be in compliance with the terms and conditions of the individual NPDES permit. Information about the applicability of the NPDES permit for surface discharging private sewage disposal systems shall be obtained from USEPA or IEPA.

(Source: Added at 37 Ill. Reg. 14994, effective August 28, 2013)

**Section 905.120 Disinfection**

- a) As of January 1, 2014, the effluent from any new, repaired or replaced private sewage disposal system that is designed and approved to have a discharge point shall be disinfected prior to discharge.
- b) Chlorine Feeders. Chlorination equipment shall have a means of removal of solids. Appendix A, Illustration S provides an example of a typical chlorine feeder. All chlorine feeders shall meet the requirements of Appendix A, Illustration S. Other feeders that meet the requirement of this Section are also acceptable.
- c) Chlorine Contact Tanks. Chlorine contact tanks shall be baffled and shall provide a contact time of at least 30 minutes based on 2½ times the average flow. The minimum contact tank capacity shall be 30 gallons. Access to the distribution feeder shall extend to the ground surface.
- d) Chlorine Residual. A final effluent free chlorine residual of 0.2 to 1.5 mg/1 shall be maintained.
- e) Chlorine products used for the disinfection of treated wastewater effluent shall be used according to the product's labeling.
- f) After January 1, 2014, any disinfection process or equipment that does not meet the requirements of NSF International/ANSI Standard 46, Section 11 or does not provide proper disinfection as determined by adequate third party testing will not be approved for installation.
- g) When the private sewage disposal system incorporates a discharge to a subsurface seepage system as a method to reduce the amount of effluent at the discharge point, the disinfection device shall be the last component prior to the discharge point.

(Source: Amended at 37 Ill. Reg. 14994, effective August 28, 2013)

**Section 905.125 Pumps, Pumping/Dosing Chambers, and Ancillary Equipment**

- a) Pumps shall meet the following requirements:
  - 1) The pump shall be submersible.
  - 2) The pump shall be designed to handle wastewater and a minimum of ½-inch diameter solids.
  - 3) The pump shall be capable of delivering the required flow at the design total dynamic head. The discharge pipe shall be the same size or larger than the discharge of the pump.
  - 4) The pump shall be constructed of corrosion-resistant materials.
  - 5) Performance curves and specification sheets indicating that the criteria of this subsection (a) have been met shall be submitted with the plan review application when pumps are to be used in a system.
  
- b) Pumping Chambers
  - 1) The pumping chamber shall be watertight, meaning that all joints shall be sealed. The pumping chamber shall be filled with water after being installed and backfilled to prevent the pumping chamber from floating out of position because of hydrostatic pressures, unless the tank is installed in dry soil.
  - 2) The volume of the pumping chamber shall be sufficient to provide the desired dosing volume, space for controls, space for setting the pump, reserve capacity malfunction and flow-back after the pump shuts off (volume of manifold and laterals).
  - 3) A reserve capacity above the active pumping volume equal to ½ day's design flow shall be provided if single pumps are used. A reserve volume is not needed if siphons or dual pumps are used.
  - 4) An access riser shall extend at least 6 inches above the ground surface.
  - 5) The dosing volume shall be at least 5 times the pipe volume of the dosing network and provide for filling and drainback of the network. The average flow shall be used to determine the dosing volume.
  - 6) The pump control device shall be adjustable so that the required dosing volume is discharged during each pumping cycle. The control system for the pumping chamber shall consist of a control for operating the pump and an alarm system to detect when the system is malfunctioning. Pump

77 ILLINOIS ADMINISTRATIVE CODE 905  
OCTOBER 2013

controls shall allow flexibility in adjusting the on-off depth. An example of acceptable controls is shown in Appendix A, Illustration Q.

- 7) A high water alarm shall be provided with audible and visual signals and a test function. The alarm shall be on a separate circuit. The alarm control device shall be a sealed float or diaphragm switch and shall be located to activate 2 to 3 inches above the pump turn-on level or siphon activation level. After January 1, 2014, all electrical devices for new and repaired private sewage disposal systems shall comply with Section 905.20(k).

c) Ancillary Equipment

- 1) A quick disconnect device shall be included in the discharge piping to facilitate removal of the pump for inspection, repair or replacement. The disconnect device shall be a threaded union, pitless adapter or lift-out rail system.
- 2) A corrosion-resistant rope or cable of adequate strength shall be affixed to the pump to facilitate installation and removal so that personnel need not enter the chamber to disconnect the pump.
- 3) A pump control device shall be adjustable so that the desired dosing volume can be discharged during each pumping cycle. The control device may consist of one or more sealed float or diaphragm switches that may cooperate with a relay or contact. Separate control panels located outside the chamber shall be protected from the weather and shall provide no air path between the panel and the pumping chamber.
- 4) A check valve between the pump and the piping network shall not be allowed unless this piping system is below the frost line.

(Source: Amended at 37 Ill. Reg. 14994, effective August 28, 2013)

**Section 905.130 Human Waste Disposal**

- a) **General.** Privies, portable toilets, recirculation toilets, incinerator toilets and compost toilets are approved for private sewage disposal of human wastes. Other domestic wastes shall be disposed of in a conventional system (see Section 905.30); however, the size of all components, as designed in accordance with Appendix A, Illustration A, may be reduced 25 percent (except that septic tanks may not be smaller than 750 gallons). Note: Compost toilets may be used to dispose of other organic domestic wastes.
- b) **Privy Construction.** All privies shall be constructed and maintained in accordance with the following and Appendix A, Illustration T:
  - 1) **Pit Construction.** The pit shall be constructed of materials and in a manner so as to be able to endure the anticipated load and use and to withstand the local environmental conditions without deteriorating. The pit shall be constructed so that there shall be access to the pit for pumping and cleaning.
  - 2) **Pit Size.** The pit shall have a minimum capacity of 50 cubic feet per seat.
  - 3) **Floor and Seat Riser.** The floor and seat riser shall be constructed of an impervious material and in a manner to exclude insects and rodents. The seat riser shall be bonded to the floor to prevent seepage through the riser onto the floor.
  - 4) **Seat Cover.** The seat opening shall be covered with a hinged lid that forms a tight seal.
  - 5) **Vent.** Each pit or vault privy shall be provided with a vent to the outside that creates airflow out of the building through the vent. The vent opening shall be screened with 16 mesh screen to prevent the entry of flies and shall terminate through the roof.
  - 6) **Maintenance.** When any privy is filled to within 18 inches of the bottom of the riser, it shall be pumped by a private sewage disposal system pumping contractor.
  - 7) **Abandonment.** Privies that are no longer in use shall be completely pumped. The floor and walls shall be cracked or crumbled so that the tank or pit will not hold water, and the tank or pit shall be filled with sand or soil. If the tank or walls are removed from the ground, the excavation shall be filled with soil.
- c) **Vault Privy.** Watertight, non-metal vaults are required where privies are used in areas where the groundwater or limestone formations are within 4 feet of the

77 ILLINOIS ADMINISTRATIVE CODE 905  
OCTOBER 2013

bottom of the pit. The vault shall be provided with a readily accessible cleanout that prohibits the entry of rodents, insects and surface water. (See Appendix A, Illustration T.)

- d) Septic Privy. The vault of a septic privy shall be watertight. The subsurface seepage field shall consist of a minimum of one 10-foot distribution line placed in a 2-foot wide trench constructed in accordance with Section 905.60 and Appendix A, Illustration U.
- e) Re-circulating Toilets
  - 1) Self-contained toilets that treat and re-circulate the flushing liquid shall be constructed of an impervious, easily cleanable material and vented to the outside air through a screened pipe. The effluent, if any, from the re-circulating toilet shall discharge into a subsurface seepage field or into a disposal bag. The subsurface seepage field shall consist of a minimum of one 10-foot long distribution line placed in a 2-foot wide trench constructed in accordance with Section 905.60. The owner of a re-circulating toilet shall dispose of any residual from the unit in an approved public or private sewage disposal system.
  - 2) Re-circulating toilets shall comply with the requirements of the NSF International/ANSI Standard 41 and shall bear the NSF International or the approved certification agency seal.
- f) Incinerator Toilets
  - 1) Incinerator toilets shall be designed and operated to provide complete incineration of the contents without production of odors. The owner of an incinerator toilet shall maintain the toilet and dispose of the contents in accordance with Section 905.170(e).
  - 2) Incinerator toilets shall comply with the requirements of NSF International/ANSI Standard 41 and shall bear the NSF International or the approved certification agency seal.
- g) Compost Toilets
  - 1) Compost toilets shall be designed in accordance with the manufacturer's recommendations to serve the anticipated number of persons. The owner of a compost toilet shall maintain the toilet and dispose of the contents in accordance with Section 905.170.
  - 2) Compost toilets shall comply with the requirements of NSF International/ANSI Standard 41 and shall bear the NSF International or the approved certification agency seal.

77 ILLINOIS ADMINISTRATIVE CODE 905  
OCTOBER 2013

(Source: Amended at 37 Ill. Reg. 14994, effective August 28, 2013)

**Section 905.135 Portable Sanitation**

- a) Any person operating in Illinois who sells, rents, leases, transports, services, cleans, sanitizes or maintains a portable toilet or portable potable hand washing unit or pumps, transports or disposes of waste from portable toilets or portable potable hand washing units shall be licensed as a portable sanitation business.
- b) Only a portable sanitation technician or portable sanitation technician trainee certified by the Department as working for a portable sanitation business may service, clean, sanitize or maintain a portable toilet or portable potable hand washing unit, or pump, transport or dispose of waste from portable toilets or portable potable hand washing units.
- c) Any person licensed as a private sewage disposal system pumping contractor on or after January 1, 2014 may submit to the Department a completed application and fee, within 6 months after January 1, 2014, requesting to be licensed as a portable sanitation business. A person licensed as a private sewage disposal system pumping contractor on January 1, 2014 may submit to the Department a completed application and fee to be certified as a portable sanitation technician without taking the examination or initial training required for the portable sanitation technician certification. After July 1, 2014, all persons wanting to become certified as a portable sanitation technician shall complete the training requirements of this Section.
- d) Any person wishing to obtain a license as a portable sanitation business shall:
  - 1) Submit to the Department a completed application on forms provided by the Department;
  - 2) Provide a copy of the business' education and training materials and protocol for educating and training for all employees requiring certification by the Department;
  - 3) Provide a written statement signed by the owner or authorized representative specifying that only certified portable sanitation technicians and portable sanitation technician trainees will be transporting, servicing, cleaning, sanitizing or maintaining portable toilets or portable potable hand washing units, or pumping, transporting or disposing of waste from portable toilets or portable potable hand washing units for the business; and
  - 4) Submit a non-refundable fee for the license as established in Section 905.200.



- e) A portable sanitation business license shall expire on June 30 of each year, except that a license issued after April 1 and before June 30 shall expire on June 30 of the following year.
- f) Certification of Employees
  - 1) A portable sanitation business shall submit the following materials to the Department as part of the certification process of a portable sanitation technician trainee:
    - A) A completed application on a form provided by the Department;
    - B) A non-refundable fee as established in Section 905.200; and
    - C) For initial application, a copy of the individual's certificate of completion from an approved training course; and for annual renewal of the certification, documentation of attendance at an approved continuing education course.
  - 2) A portable sanitation business shall submit the following materials to the Department as part of the certification process of a portable sanitation technician:
    - A) A completed application on a form provided by the Department;
    - B) A non-refundable fee as established in Section 905.200; and
    - C) For initial application, a copy of the individual's certificate of completion from an approved training course; and for annual renewal of the certification, documentation of attendance at an approved continuing education course.
- g) Portable Sanitation Technician Trainee
  - 1) To become certified as a portable sanitation technician trainee, an individual shall:
    - A) Be an owner or employee of a licensed portable sanitation business; and
    - B) Complete an initial training or an education course provided by the portable sanitation business and approved by the Department.
  - 2) The application shall be submitted on forms provided by the Department and accompanied by the fee established in Section 905.200.

- 3) The portable sanitation technician trainee certification is valid for only one year. A portable sanitation technician trainee certification shall expire on June 30 of each year, except that a certification issued after April 1 and before June 30 shall expire on June 30 of the following year.
- h) Portable Sanitation Technician
- 1) To become certified as a portable sanitation technician, an individual shall:
    - A) Be an owner or employee of a licensed portable sanitation business;
    - B) Complete training and an education course provided by and specific to the portable sanitation business; this training shall be pre-approved by the Department; and
    - C) For the original certification, provide a copy of the employee's documentation of attendance and passing grade for the training and examination offered by the Department or a training and testing program approved by the Department. For renewal of the certification, the employee shall provide copies of the employee's documentation of attendance at a continuing education course in accordance with Section 905.200.
  - 2) The application shall be submitted on forms provided by the Department and accompanied by the fee established in Section 905.200.
- i) For the attendee to receive credit to be used for obtaining or renewing certification, education courses and continuing education course curricula shall have Department approval prior to the attendee's attending the course. Courses not pre-approved by the Department shall not be counted toward training or continuing education.
- j) The examination for a portable sanitation technician certification shall test the applicant's knowledge of safely pumping, cleaning and sanitizing portable toilets and portable potable hand washing units and hauling and disposing of wastes removed from portable toilets and portable potable hand washing units.
- k) An individual shall achieve a grade of 70% or higher to pass an examination for a portable sanitation technician certification.
- l) The portable sanitation technician certification shall be renewed annually. A portable sanitation technician certification shall expire on June 30 of each year, except that an original certification issued after April 1 and before June 30 shall expire on June 30 of the following year. If a renewal application is mailed or

received after June 30, a non-refundable reinstatement fee will be required as provided in Section 905.200.

- m) The portable sanitation business is accountable for the following work conducted by individuals certified by the business:
- 1) Cleaning, servicing and replenishing required items or chemicals for each portable toilet or portable potable hand washing unit serviced, inspected or maintained;
  - 2) Pumping, transporting or disposing of waste from portable toilets or portable potable hand washing units.
- n) Standards for Constructing and Servicing Portable Toilets or Portable Potable Hand Washing Units  
Portable toilets or portable potable hand washing units shall be constructed and serviced in the following manner:
- 1) Rooms, buildings or shelters housing portable toilets shall be of solid construction, easy to clean and providing shelter and privacy. The portable toilet room shall be ventilated to the outside, with the vent covered with 16-mesh screen. Internal latches shall be provided for the doors to the portable toilets to prevent inadvertent entry.
  - 2) Waste containers and portable potable water containers shall be fabricated from impervious materials such as plastic, steel, fiberglass or their equivalents. Containers shall be watertight and capable of containing the waste and portable potable water.
  - 3) Number of Portable Toilets and Portable Potable Hand Washing Units at a Site
    - A) An adequate number of portable toilets and portable potable hand washing units shall be provided to be used by the number of persons anticipated.
    - B) The portable toilets and portable potable hand washing units shall be serviced at a frequency that maintains the units in a sanitary condition and free of odors.
    - C) The employer, property owner or event coordinator shall acquire more units or adjust the service and maintenance frequently to ensure sanitary conditions.
    - D) The property owner's failing to provide a sufficient number of portable toilets or portable potable hand washing units or a

frequency of service and maintenance capable of ensuring a sanitary condition is a violation of the Act and this Part.

- 4) Servicing shall include removing waste from containers; recharging containers with an odor-controlling solution; installing a supply of toilet tissue, sanitary single use towels, and liquid soap and refilling hand sanitizing solution, based on the unit's intended use; and cleaning and sanitizing the portable toilets and hand washing units.
  - A) Each portable toilet and portable potable hand washing unit shall be thoroughly cleaned and sanitized after each pumping or as part of the routine service. Areas that shall be cleaned and sanitized include all internal parts of the unit, which include the urinal, seat, counters, shelves, tank, walls, floor, door and ceiling, in addition to the exterior of the door and handle.
  - B) The portable toilet system contractor shall have 2 separate sets of cleaning equipment, which shall be labeled and stored so that they are physically separated from each other. One set shall be used to clean and sanitize the walls, counters, shelves, handle, door and ceiling of the portable toilets and the portable potable hand washing units. The second set of cleaning and sanitizing equipment shall be used for the floors, urinals, seat and tank of the portable toilet. If the units are cleaned and sanitized with a power washer, separate sets of cleaning equipment are not needed.
  - C) Anti-bacterial hand sanitizer shall be provided at each unit and shall be refilled at each pumping, as needed. One portable potable hand washing unit with a supply of sanitary single-use towels and soap may be provided for up to 5 portable toilets in lieu of refilling anti-bacterial hand sanitizer at each unit. The hand washing facility shall be located within 20 feet of the portable toilets. The dispensers and hand washing facilities shall be cleaned and sanitized after each pumping, and then refilled with potable water from an approved source.
- 5) After a unit is cleaned and sanitized, it shall be inspected by the person designated by the business to ensure that the unit is in compliance with this Section and all other applicable Sections of this Part.
- 6) Any defective portable toilets or portable potable hand washing units shall be repaired or withdrawn from service by locking or removal.
- 7) Waste shall be removed in a sanitary manner by means of a vacuum hose and discharged to a leak-proof tank truck. All ports on the tank shall be valved and capped.

- 8) Service trucks shall have access to the toilets to be serviced.
  - 9) The service trucks and disposal of waste from tank trucks shall be in accordance with Section 905.170(g).
  - 10) A business shall designate at least one representative who shall be responsible for ensuring that each unit maintained by the business meets the standards of cleanliness set forth in the Act and this Part.
  - 11) Persons engaged in cleaning and sanitizing units shall wear protective equipment and be trained in proper procedures for cleaning, sanitation and self-protection.
  - 12) All portable sanitation businesses shall certify that the portable sanitation technicians and portable sanitation technician trainees are capable of properly cleaning and sanitizing a portable toilet and portable potable hand washing unit. At a minimum, the business shall annually inspect each portable sanitation technician's and portable sanitation technician trainee's work to ensure that he or she is capable and can effectively clean and sanitize the portable toilets and portable potable hand washing units to be serviced.
- o) Violations of the Act or any Section of this Part may result in a fine, civil penalty and suspension, revocation or refusal to issue a license or certification for both the portable sanitation business and the certified portable sanitation technician or portable sanitation technician trainee.

(Source: Added at 37 Ill. Reg. 14994, effective August 28, 2013)

**Section 905.140 Holding Tanks**

- a) General. Holding tanks are approved for private sewage disposal only under the following circumstances:
- 1) Where site conditions, such as type of soil, water table, terrain, lack of size or other conditions, are not suitable to achieve compliance with this Part for installing a private sewage disposal system.
  - 2) As a temporary measure while awaiting the availability of a municipal sewer extension. This temporary condition shall not exceed one year in length.
  - 3) As a sanitary dumping station to receive the discharge from holding facilities on recreational vehicles.
  - 4) To receive the discharge from fixtures or drains that receive waste products such as automotive grease, oils, solvents and chemicals that are not allowed to be discharged into a private sewage disposal system. These waste products shall be handled according to rules for the disposal of oil, gas and grease promulgated under the Environmental Protection Act, or according to 35 Ill. Adm. Code Subtitle G, or shall be taken to an oil and gas reclamation center. (Also see the Illinois Plumbing Code.) Holding tanks to be used as described in this Section shall be Underwriters Laboratories, Inc. certified, constructed of materials approved for gas and oil interceptors as specified in 77 Ill. Adm. Code 890.520, and properly anchored to prevent flotation.
- b) Approval. Approval for holding tanks shall be obtained in writing from the Department or local authority prior to installation. Approval shall be based on compliance with this Section.
- c) Construction and Location. Holding tanks shall be designed and constructed in compliance with Section 905.40 (Septic Tanks), except that the outlet shall be permanently sealed. Holding tanks shall be located to comply with the requirements for septic tanks and aerobic treatment plants (see Appendix A, Illustration D).
- d) Conversion to Conventional Private Sewage Disposal Systems. Holding tanks installed under subsection (a)(2) shall be converted to a conventional private sewage disposal system within one year after the original installation if a municipal sewer has not been extended to serve the property.

(Source: Amended at 37 Ill. Reg. 14994, effective August 28, 2013)

**Section 905.150 Sanitary Dump Stations**

- a) General. Sanitary dump stations which receive the discharge of holding tanks on recreational vehicles shall be designed and constructed in accordance with the Recreational Area Code (77 Ill. Adm. Code 800), Appendix A: Illustration V of this Part and the following requirements:
  - 1) A sanitary dump station with a disposal system shall be designed on the basis of 20 gallons per day per unsewered recreational vehicle site.
  - 2) A sanitary dump station with only holding capabilities shall be designed on the basis of 140 gallons per unsewered recreational vehicle site.
- b) Construction and Location. The construction and location of a sanitary dump station with a disposal system shall comply in all respects with the applicable Sections of this Part, depending on the type of system used. The location and construction of a sanitary dump station with only holding capabilities shall comply with the requirements of Section 905.140.
- c) Ancillary Requirements. A sanitary dump station shall be provided with the following:
  - 1) A concrete pad sloped at least one inch per 10 feet to a drain. This pad shall extend at least 2 feet in every direction from the drain, and shall have at least a 2 inch high curb around the outside perimeter of the pad as indicated in Appendix A: Illustration V of this Part.
  - 2) A foot-operated, self-closing cap which forms a tight seal with the drain shall be provided.
  - 3) The sewer line from the drain to the tank shall be at least 4 inches in diameter and constructed of material approved under Section 905.20(f). It shall be installed to maintain at least a 10 foot horizontal separation between the water and sewer line, and the water line and the tank.
  - 4) A water supply distribution tap for flushing the pad shall be provided. The water supply line to the tap shall be of materials, location, and construction in accordance with the Illinois Plumbing Code (77 Ill. Adm. Code 890), and shall be provided with approved, properly installed back siphonage protection. No "stop and waste" valves will be allowed on this tap. This water tap shall be posted, "Not for Human Consumption. Use for Flushing and Cleaning Purposes Only."

(Source: Amended at 20 Ill. Reg. 2431, effective March 15, 1996)

**Section 905.160 Swimming Pool Wastewater**

- a) General. Wastewater generated from the operation of a swimming pool includes clear wastes, such as drainage from the pool proper, deck drainage, and perimeter overflow system drainage, and turbid wastes, such as filter wash and backwash water.
- b) Approved Treatment and Disposal. Wastewater from swimming pools may not be discharged to a private sewage disposal system receiving domestic sewage. It shall be disposed of in the following manner:
  - 1) Clear water wastes may be discharged directly to storm sewers, natural drainage areas, or to the ground surface without additional treatment. Such drainage shall not result in nuisance conditions which create an offensive odor, or which produce a stagnant wet area, or which produce an environment for the breeding of insects. These discharges will require an NPDES Permit from IEPA if contaminants are added to the discharge that will cause any water quality violation.
  - 2) Wash or backwash water from sand filters may be discharged to natural drainage areas, storm sewers, seepage pits, or to the ground surface. Diatomaceous earth filter wash or backwash water may be discharged to one of the above after treatment consisting of one of the following:
    - A) Passing the wastewater through a separation tank designed for removal of the diatomaceous earth and suspended solids.
    - B) Settling the wastewater in a tank which is capable of holding the volume of one backwash. One backwash is defined as the amount of water generated from the backwash of the filters for a period of 2 minutes for diatomaceous earth filters, at the required backwash flow rate. The tank shall be dewatered after settling and prior to subsequent backwashes. Settled sludge shall be periodically removed to prevent flushing of solids during backwashing. (See Appendix A: Illustration W of this Part.)
    - C) A separate private sewage disposal system designed and constructed in accordance with the applicable Sections of this Part.

(Source: Amended at 20 Ill. Reg. 2431, effective March 15, 1996)



**Section 905.170 Servicing, Cleaning, Transporting and Disposing of Wastes from Private Sewage Disposal Systems**

- a) General. The collection, storage, transportation, and disposal of all septage shall be handled in accordance with this Section and in accordance with 40 CFR 503 – Standards for the Use or Disposal of Sewage Sludge.
- b) Truck Identification. The name under which the business is conducted and the town of company origin and telephone number of the business shall be painted on each side of every pumper truck. The company name shall be easily legible and the letters shall be at least 8 inches high in contrasting colors.
- c) Equipment Inspection. Equipment shall be subject to inspection and approval by a representative of the Department or local authority at any reasonable time and, upon request, shall be available for inspection at a designated location.
- d) Vehicle Construction and Equipment. Each vehicle used for collection and transportation of waste shall be equipped with a leakproof and tightly sealed tank for septage hauling. The interior and exterior sections of all portable containers, pumps, hoses, tools, or other implements that have been contaminated shall be rinsed clean after each use and the rinsings shall be disposed of such that no health hazard or nuisance results. Trucks and tanks shall comply with the following:
  - 1) The vehicle shall be equipped with either a vacuum pump or other type of pump that is self-priming and will not allow any seepage from the diaphragm or other packing glands.
  - 2) The discharge nozzle shall be located so that there is no flow or drip onto any portion of the truck.
  - 3) The discharge nozzle shall be capped when not in use.
- e) Notification of Disposal Site. Annually, the private sewage disposal system pumping contractor shall:
  - 1) Notify the Department and local authority of the sites utilized for disposal. Information to be reported shall be: county, township, range, and section, with a description to the nearest ¼ section; name and address of the owner of the property; and purpose for which the disposal site is otherwise used, such as pasture, grain crops, mowing crops, or timber.
  - 2) Provide an annual estimate of the total gallons of septage disposed of at each site.
  - 3) Describe the methods of disposal at each site.

77 ILLINOIS ADMINISTRATIVE CODE 905  
OCTOBER 2013

- f) Disposal Methods. Methods of septage disposal approved by the Department are as follows:
- 1) Discharge to a Municipal Sanitary Sewer System. Discharge to a municipal sanitary sewer system is approved when the municipality has approval from the Illinois Environmental Protection Agency to receive septage from private sewage disposal systems; and the contractor has written approval from the municipality to discharge septage into the system.
  - 2) Application to Agricultural Land. Septage may be applied to agricultural land provided the following criteria are met:
    - A) The depth to the groundwater table or to fractured limestone formations is at least 4 feet below the ground surface.
    - B) The septage is disposed of in the following manner:
      - i) It originates from private sewage disposal systems that treat only domestic sewage as that term is defined in Section 3 of the Private Sewage Disposal Licensing Act [225 ILCS 225/3];
      - ii) It is not applied to land that has been saturated by rainfall during the 24-hour period preceding the intended application time;
      - iii) It is not applied to land with water ponded upon it;
      - iv) It is not applied to land within 200 feet of wells, homes, the rim of a sink hole, underground mine, cave, tunnel, other water supplies, ponds or streams;
      - v) It is not applied to land having greater than 5% slope;
      - vi) It is not applied to land that is intended to grow root vegetables, or other low growing fruits or vegetables that may be eaten raw;
      - vii) It is applied at a rate that does not exceed the agronomic rate required by USEPA regulations (40 CFR 503);
      - viii) It is applied from a vehicle moving at least one mile per hour (88 feet per minute);

77 ILLINOIS ADMINISTRATIVE CODE 905  
OCTOBER 2013

- ix) Where it is determined by the Department or local authority that a nuisance condition (see Section 905.160(b)(1)) exists, then the septage shall be incorporated into the soil.
- 3) Discharge to Sludge Lagoons or Sludge Drying Beds. Discharge to a sludge lagoon or drying bed must be approved by the Illinois Environmental Protection Agency (IEPA) (35 Ill. Adm. Code 309) or the owner/operator of the lagoon or drying bed must have a permit from the IEPA to receive septage from the contractor. If the contractor is going to construct a sludge lagoon or drying bed, a permit will be necessary from the IEPA to construct and operate the proposed facility.
- 4) Discharge to an Incinerator Device. Discharge of septage to an incinerator must be approved by the IEPA or the owner/operator of the incinerator must have a permit from the IEPA to receive septage from the contractor.
- 5) Discharge to a Sanitary Landfill. Discharge of septage to a sanitary landfill must be approved by the IEPA or the owner/operator of the landfill must have a permit from the IEPA to receive the septage from the contractor.
- g) Methods for the disposal of waste from portable toilets shall be as follows:
  - 1) Discharge to a Municipal Sanitary Sewer System. Discharge to a municipal sanitary sewer system is approved from private sewage disposal systems when the contractor has written approval from the municipality to discharge septage into the system.
  - 2) Discharge to Sludge Lagoons or Sludge Drying Beds. Discharge to a sludge lagoon or drying bed must be approved by the Illinois Environmental Protection Agency (IEPA) (35 Ill. Adm. Code 309) or the owner/operator of the lagoon or drying bed must have a permit from the IEPA to receive septage from the contractor. If the contractor is going to construct a sludge lagoon or drying bed, a permit will be necessary from the IEPA to construct and operate the proposed facility.
  - 3) Discharge to an Incinerator Device. Discharge of septage to an incinerator must be approved by the IEPA or the owner/operator of the incinerator must have a permit from the IEPA to receive septage from the contractor.
  - 4) Discharge to a Sanitary Landfill. Discharge of septage to a sanitary landfill must be approved by the IEPA or the owner/operator of the landfill must have a permit from the IEPA to receive the septage from the contractor.
- h) Other Wastes. The following shall not be disposed of by application to

77 ILLINOIS ADMINISTRATIVE CODE 905  
OCTOBER 2013

agricultural land:

- 1) Waste from a portable toilet; and
- 2) Holding tank waste as provided in Section 905.140(a)(4).

(Source: Amended at 27 Ill. Reg. 3074, effective February 10, 2003)

**Section 905.180 Examinations for Licensure**

- a) Applications
  - 1) Each person who desires to apply for admittance to the examination for a Private Sewage Disposal System Installation Contractor license or a Private Sewage Disposal System Pumping Contractor license shall file an application for examination on forms provided by the Department. These forms may be obtained by writing to the Illinois Department of Public Health, Division of Environmental Health.
  - 2) The Department will establish examination dates and locations. A completed application, a photograph of the applicant, and a fee of \$100 for each examination shall be filed with the Department at least 30 days prior to the examination date.
- b) Examination Requirements and Results
  - 1) Installation License Examination. The examination for a Private Sewage Disposal System Installation Contractor license shall test the applicant's knowledge of the design, installation, operation, maintenance, repair and service of private sewage disposal systems.
  - 2) Pumping Licensing Examination. The examination for a Private Sewage Disposal System Pumping Contractor license shall test the applicant's knowledge of pumping, hauling and disposing of wastes removed from private sewage disposal systems.
  - 3) Individuals desiring both the installation contractor license and pumping contractor license shall pass the examination for each license.
  - 4) Passing Grade. The examination shall consist of questions with a combined grade value of 100 points. To successfully pass the examination, a grade of not less than 70 shall be obtained.
  - 5) Failure to Attend an Examination. Any person who fails to notify the Department in writing by letter, fax or e-mail at least 2 working days prior to the date of the examination and fails to attend the examination will be required to resubmit an application and fee to be eligible to take an examination on another date. If an emergency or severe weather conditions do not allow an individual to attend an examination, the individual may make a written request to the Department explaining why the individual was unable to attend. The Department will review the request and, if the request is accepted, the individual will not be charged a new application fee to reschedule the examination.

- c) Regulator Exemption
- 1) Currently employed staff of the Department or an agent of the Department, local health department or municipalities administering the Private Sewage Disposal Program may apply to take an examination. The fee for the examination will be waived, but in waiving the fee the individual, upon passing the examination, will not be able to act as a licensee or perform the duties empowered under the Act and this Part for the specific license. Taking the examination will only verify and evaluate the individual's knowledge of this Part.
  - 2) If an individual is employed by the Department or is an agent of the Department, local health department or municipality and is licensed as a private sewage disposal installation contractor, private sewage disposal pumping contractor, portable sanitation technician or portable sanitation technician trainee, the individual may not perform the duties empowered under the license or certification within the State. This subsection (c)(2) applies to individuals employed at the Department or as agents that evaluate and approve construction permits for private sewage disposal systems, inspect private sewage disposal systems or enforce the Act and this Part within their jurisdiction.

(Source: Amended at 37 Ill. Reg. 14994, effective August 28, 2013)

**Section 905.190 Installation Approval**

- a) Plan approval shall be obtained from the Department or local authority prior to beginning any construction of a new private sewage disposal system. A new private sewage disposal system shall consist of, but not necessarily be limited to, the following:
  - 1) A system where a septic tank is replaced or where a major component of the system is removed or added. Examples of major components would be the replacement or addition of an aeration unit, re-circulating sand filter, sand filter, seepage pit, seepage bed or waste stabilization pond.
  - 2) A system where the size of the absorption field is increased by 25% or more or where 25% or more of the existing absorption field is removed and replaced with new piping and backfill material.
- b) Requests for approval shall be submitted on the forms provided by the Department or local authority. At a minimum, the necessary information that shall be submitted to the Department or local authority for approval shall consist of:
  - 1) Plans or drawings to scale indicating lot size with dimensions showing the location of the system and type of system to be constructed; the dimensions and the length of lateral pipe to be installed, showing type of backfill material if applicable; distances to water lines, water wells, potable water storage tanks and buildings; site elevations and ground surface elevations sufficient to determine the elevation of system components and the slope of the ground surface; location of sanitary sewer, if available, within 300 feet of the property; and typical cross-section of the system.
  - 2) Number of bedrooms or design volume.
  - 3) Soil investigation results or percolation test results and the separation distance from the trench bottom to a limiting layer. The private sewage disposal system installation contractor or homeowner shall submit information with the plan approval application or local authority permit application that a limiting layer does not exist within the distances provided in Section 905.60(a)(7).
  - 4) Owner's name and address.
  - 5) Name and signature of applicant.
- c) The applicant's signature serves as written acknowledgement that the property owners are aware of and accept the responsibility to service and maintain the

private sewage disposal system in accordance with the Private Sewage Disposal Licensing Act and this Part. If the owner of the site is a developer or contractor, he or she shall notify the purchaser and the Department or the Department's agent of the transfer of ownership and responsibility for maintenance.

- d) Persons who construct, install, repair or modify a private sewage disposal system shall notify the Department or local authority at least 48 hours prior to commencement of the work.
- e) If any person constructs, installs, repairs or modifies a private sewage disposal system without complying with the requirements of subsections (a) through (d) of this Section and backfills any portion of the system or covers any portion of the system with earth, cinders, gravel, shale or any other material that will prevent the Department or local authority from viewing the system to determine compliance with this Part, the property owner or private sewage disposal installation contractor shall uncover the backfilled or covered portions of the system.
- f) **Contractor Responsibility.** The private sewage disposal installation contractor is responsible for percolation test results and the sewage disposal system that is designed and constructed using those results. Acceptance of percolation tests from other sources does not relieve the installation contractor from responsibility. The private sewage disposal system installation contractor is also responsible for the following:
  - 1) Constructing, installing, repairing, modifying, or maintaining the private sewage disposal system in accordance with this Part;
  - 2) Providing the results of soil classification information or percolation tests used to design a private sewage disposal system to the property owner and retaining copies of this information for at least 5 years;
  - 3) Providing service to aerobic treatment plants at least equal to Section 905.100(g); and
  - 4) Assuring compliance with all codes that may apply to the system, including the National Electrical Code.
- g) **Soil Classifier Responsibility.** The soil classifier or Illinois licensed professional engineer shall be responsible for the accuracy of the information from soil investigations used to design private sewage disposal systems.

(Source: Amended at 37 Ill. Reg. 14994, effective August 28, 2013)



**Section 905.200 Licenses and Fees**

- a) An individual may obtain a license as a private sewage disposal system pumping contractor or a private sewage disposal system installation contractor upon successfully passing the examinations given for each, then applying on forms provided by the Department and submitting the annual license fee of \$100 to the Department.
- b) *Each person who holds a currently valid plumbing license issued under the Illinois Plumbing License Law [225 ILCS 320] shall not be required to pay the annual license fee, but shall comply with all other provisions of the Act and this Part, including the requirement for examination for licensure. (Section 5(a) of the Act)*
- c) The fee to be paid for the annual renewal of either a private sewage disposal system pumping contractor or a private sewage disposal system installation contractor license shall be \$100.
- d) The fee to be paid for the reinstatement of a private sewage disposal system pumping contractor license or a private sewage disposal system installation contractor license that has expired for a period of less than 3 years shall be \$50, plus all lapsed renewal fees.
- e) A license that has expired for more than 3 years may be restored only by passing the written examination and paying the required fees.
- f) A person who does not obtain a license within 2 years after successfully completing the appropriate examination shall be required to file a new application and fee with the Department in accordance with Section 905.180(a) and again successfully pass the examination prior to applying for a license.
- g) *The Department shall reinstate a license that expires while a licensee is in the active military service of the United States upon application to the Department by the former licensee within two years after termination of military service, payment of the annual license fee and submission of evidence of military service. The license shall be reinstated without examination and without payment of the reinstatement fee.(Section 5(b) of the Act)*
- h) *As of January 1, 2014, all individuals licensed as a private sewage disposal system pumping contractor or a private sewage disposal system installation contractor or certified as a portable sanitation technician shall be required to obtain 3 hours of continuing education prior to the renewal of the license. The Department will review and approve continuing education hours, based on whether the content of the course is current and pertinent to the advancement and knowledge level of the industry. For individuals to receive credit for education, continuing education courses shall be approved by the Department prior to the*

course being offered. The contractor shall submit the certificate of completion of the required education to the Department for approval prior to the reissuance of the licenses.

- i) The fee to be paid for the original license of a portable sanitation business and for the annual renewal of a license of a portable sanitation business shall be \$250.
- j) The original and annual renewal fee to be paid for the certification of a portable sanitation technician shall be \$50.
- k) The fee to be paid for the certification of a portable sanitation technician trainee shall be \$50.
- l) The fee to be paid for the reinstatement of a portable sanitation business license that has expired for a period of less than 3 years shall be \$100, plus all lapsed renewal fees.
- m) The fee to be paid for the reinstatement of a portable sanitation technician certificate that has expired for a period of less than 3 years shall be \$50, plus all lapsed certification fees.
- n) Private sewage disposal system installation contractor or private sewage disposal pumping contractor licenses shall be renewed by November 30 of each calendar year. Individuals who fail to renew a private sewage disposal system installation contractor or private sewage disposal pumping contractor license prior to December 1 will be required to pay the reinstatement fee of \$50. A license cannot be issued until all fees have been paid.
- o) Portable sanitation business licenses shall be renewed by April 30 of each calendar year. Businesses that fail to renew a license prior to June 1 will be required to pay the reinstatement fee of \$100. A license cannot be issued until all fees have been paid.
- p) Portable sanitation technician licenses shall be renewed by April 30 of each calendar year. Individuals who fail to renew a license prior to June 1 will be required to pay the reinstatement fee of \$50. A license cannot be issued until all fees have been paid.

(Source: Amended at 37 Ill. Reg. 14994, effective August 28, 2013)

**Section 905.205 Civil Penalties and Time Allowances for Corrective Action**

- a) Amount of Penalty
  - 1) The Department may assess civil fines against any person or licensee who constructs, installs, repairs, modifies, maintains or fails to provide for required maintenance of a private sewage disposal system, or any person or licensee who pumps, hauls or disposes of wastes from a private sewage disposal system in violation of any Section of the Act or this Part.
  - 2) The Department shall determine the amount of the fine based upon the seriousness of the violation. The seriousness of the violation will be determined as follows:
    - A) Type A – violations considered the most grievous, which shall be grounds to assess a larger fine, shall be activities that create a health hazard, unlicensed activities and repeat violations. Examples of these activities include violations of vertical or horizontal separation distances, falsifying information on permits or reports, addition of prohibited materials to a private sewage disposal system, use of improper septage disposal methods and prohibited discharges. The amount of the fine shall not exceed \$1,000 for each violation in addition to \$100 per day for each day the violation continues.
    - B) Type B – violations relating to improper construction practices, the use of improper materials, failure to install a system according to the approved plan, any violation of Section 905.135 and pumper equipment violations shall be considered more serious. The maximum fine shall not exceed \$750 for each violation in addition to \$100 per day for each day the violation continues.
    - C) Type C – administrative violations involving paperwork, such as failure to obtain a permit or improper pumping truck lettering, shall be considered the least serious. The maximum fine shall not exceed \$500 for each violation, in addition to \$100 per day for each day the violation continues.
    - D) For the purposes of determining a repeat violation, an initial violation means the first violation of a particular Section of the Act or this Part within the previous 3 years. An identical or similar violation (example: a violation of vertical or horizontal separation distance or septage disposal) that occurs within a 3 year period will be considered a repeat violation.
- b) Correction of Violation. Correction of violations that are considered serious

77 ILLINOIS ADMINISTRATIVE CODE 905  
OCTOBER 2013

health hazards as determined by the Department or local health department shall begin immediately and be completed within 7 days. Other violations shall be corrected within 30 days after notification by the Department or the local health department. An exception to this requirement may be authorized by the Department or local health department when extenuating circumstances prevent correction in a timely manner. Examples of extenuating circumstances include weather, physical conditions that prevent construction or repair, or lack of adequate materials. The Department or local health department may also grant an extension of time for correction, based on the type and seriousness of the violation and the violator's demonstrated progress in correcting the violation.

- c) Any violation may be referred to the State's Attorney of the county in which it occurs or to the Attorney General for prosecution.

(Source: Amended at 37 Ill. Reg. 14994, effective August 28, 2013)

**Section 905.210 Notification of Disposal Site (Repealed)**

(Source: Repealed at 20 Ill. Reg. 2431, effective March 15, 1996)

**Section 905.APPENDIX A Illustrations and Exhibits**

**Section 905.ILLUSTRATION A Quantity of Sewage Flows**

TYPE OF ESTABLISHMENT	Unit (per)	Gallons Per Day
<b>Permanent Residential Dwellings</b>		
Single Family	bedroom	200
Multi-Family	bedroom	200
Individual Mobile Homes	bedroom	200
Mobile Home Parks	space	400
Boarding Houses	person	50
Rooming House	resident	40
<b>Institutions</b>		
Hospitals, Medical	bed	250
Hospitals, Medical	employee	15
Hospitals, Mental	bed	150
Hospitals, Mental	employee	15
Long-Term Care Institutions	bed	125
Long-Term Care Institutions	employee	15
Prison	inmate	150
Prison	employee	15
<b>Schools</b>		
Boarding School	person	150
Schools Without Cafeteria or Showers	person	15
Schools W/Cafeteria & Showers	person	25
Schools W/Cafeteria or Showers	person	20
<b>Travel</b>		
Airports	passenger	5
Railway Stations	passenger	5
Bus Stations	passenger	5
Highway Rest Areas	traveler	5
<b>Recreational &amp; Seasonal Areas</b>		
Campgrounds W/Mobile Homes	site	150

77 ILLINOIS ADMINISTRATIVE CODE 905  
OCTOBER 2013

TYPE OF ESTABLISHMENT	Unit (per)	Gallons Per Day
Swimming Pools & Bathing Beaches	person	10
Comfort Sta. W/Toilets & Showers	space	35
Comfort Sta. W/O Showers	space	25
Day Camps W/O Meals	person	25
Day Camps W/Meals	person	35
RV Parks W/Water and Sewer Hook-Ups	space	50
Cottages and/or Small Dwellings W/Seasonal Occupancy	bedroom	150
Picnic Parks W/Toilet Facilities Only	person	10
Youth Camps W/O Cafeteria	person	50
Youth Camps W/Cafeteria	person	60
Migrant Labor Camps	person	150
Sanitary Dump Station for Unsewered Site	site	20
Campground W/Central Bath and Toilet Facilities	person	35
Commercial, Industrial & Misc.		
Country Clubs, No Kitchen	member	25
Hotels & Motels	bed	50
Places for Public Assembly	person	5
Theaters	seat	5
Churches W/O Kitchen	seat	3
Churches W/Kitchen	seat	6
Restaurants	meal	10
Restaurants W/Bar & Cocktail	meal	12
Offices & Day Workers	person	15
Shopping Centers	(per 1000) sq. ft. of floor area)	250
Stores	toilet	400
Service Stations (served)	vehicle	10
Laundries	customer	50
Construction Camps or Sites, Factories W/Toilets & Showers	person	35
Factories w/Toilets, No Showers	person	20

(Source: Amended at 20 Ill. Reg. 2431, effective March 15, 1996)

Section 905.APPENDIX A Illustrations and Exhibits

**Section 905.ILLUSTRATION C List of Approved Plastic Pipe for Private Sewage Disposal System**

TYPES OF PIPES	ASTM STANDARD	BUILDING SEWER <sup>1</sup> OR COMMON COLLECTOR	SEWER LINES <sup>1</sup>	ALL SUBSURFACE SEEPAGE SYSTEMS
		5 ft. from building to septic-aeration tank to 5 ft. beyond the septic tank, aeration tank or distribution box	Additional treatment facilities and sand filter distribution lines and collection lines	
ABS (DWV Schedule 40)	F628-06	x	x	x
ABS (DWV Schedule 40)	D2661-06	x	x	x
ABS	D1527-99 (2005)	x	x	x
ABS (Sewer Pipe)	D2751-05	x <sup>2</sup>	x <sup>2</sup>	x <sup>2</sup>
PVC	D1785-06	x	x	x
PVC (DWV Schedule 40)	D2665-07	x	x	x
PVC (DWV Schedule 40)	F891-04	x	x	x
PVC (Type PSM) (SDR 35)	D3034-06	x <sup>2</sup>	x <sup>2</sup>	x <sup>2</sup>
PVC (Sewer & Drain PS-50)	F891-04	x	x	x
PVC (Sewer & Drain PS-25)	F891-04	x	x	
PVC (Corrugated-Smoothwall)	F949-06	x	x	
PVC (Std. or Perforated)	D2729-03		x	x
PE (Smoothwall)	R810-07		x	x
	AASHTO Standard M252-06			
PE (Corrugated-Perforated)	F405-05 (Heavy Duty Only)			x



77 ILLINOIS ADMINISTRATIVE CODE 905  
OCTOBER 2013

PE	(Corrugated- (Perforated)	F667-06	x
----	------------------------------	---------	---

x – Indicates approved use.

<sup>1</sup> Plastic materials shall not be co-mingled within this area except through the use of proper adapters. (See Illinois Plumbing Code.) When the building sewer is of a type of material that is different from the building drain, proper transition fittings shall be used.

<sup>2</sup> Pipe shall be SDR (Standard Dimension Ratio) 35 only.

Note: The last 2 numbers of the ASTM Standard indicate the date of the edition.

(Source: Amended at 37 Ill. Reg. 14994, effective August 28, 2013)

**Section 905.APPENDIX A Illustrations and Exhibits**

**Section 905.ILLUSTRATION D Location of Components of Private Sewage Disposal Systems**

COMPONENT PART OF SYSTEM	MINIMUM DISTANCE ALLOWABLE FROM <sup>1,2</sup>					
	Cistern Well, or Suction Line from Pump To Well FEET	Water Supply Line <sup>3</sup> Pressure FEET	Lake, Stream In ground Swimming Pool or Other Body of Water FEET	Property Dwelling FEET	Property Line <sup>4</sup> FEET	Artificial Drain FEET
Building Sewer <sup>5</sup>	50	10	25	–	–	–
Septic Tank or Aerobic Treatment Plant	50	10 <sup>9</sup>	25	5	5	–
Distribution Box	75	10	25	10	5	–
Subsurface Seepage System	75	25	25	10	5	10
Sand Filter	75	25	15	10	5	10
Privy	75	25	25	20	5	10
Waste Stabilization Pond	75	25	25	20	5	10
Surface Discharge Effluent Line	50	10	–	–	5	–
Effluent Receiving Trench	75	25	15	10	5	10
Treated Effluent Discharge Point <sup>6</sup>	50	10	–	20	25	25
Class V Injection Wells <sup>7</sup>	200 <sup>8</sup>	25	25	10	5	10

<sup>1</sup> These distances have been determined for use in clay, silt and loam soils only. The minimum distances required for use in sand or other types of soil shall be determined for the proposed private sewage disposal system and approved by the Department. Approval will be given if the Department determines that the soil will provide treatment of the sewage.

<sup>2</sup> For separation distances to closed loop wells, see 77 Ill. Adm. Code 920.180.

<sup>3</sup> See Section 905.20(d) for additional details on water line and sewer separation.

<sup>4</sup> If a common property is used, the boundary of the common property shall be used.

<sup>5</sup> The building sewer or surface discharge effluent line may be located to within 10 feet of a well or suction line from the pump to the well when cast iron pipe with mechanical joints

77 ILLINOIS ADMINISTRATIVE CODE 905  
OCTOBER 2013

or Schedule 40 PVC pipe with watertight joints is used for the building sewer or surface discharge effluent line.

<sup>6</sup> Any surface discharging system installed, repaired or renovated after January 1, 2014.

<sup>7</sup> Class V Injection Wells are defined in Illinois Pollution Control Board rules. They are typically a shallow well used to place fluids directly below the land surface. See, e.g., 35 Ill. Adm. Code 704.105, 704.106 and 704.280.

<sup>8</sup> A lesser separation distance may be obtained with approval or a waiver from IEPA.

<sup>9</sup> There shall be 25 feet separation from public water supply water mains and water service lines. The terms public water supply, water main and water service line shall have the same meaning as in the Illinois Pollution Control Board's Public Water Supplies rules. See, e.g., 35 Ill. Adm. Code 653.118 and 653.119.

(Source: Amended at 37 Ill. Reg. 14994, effective August 28, 2013)

Section 905.APPENDIX A Illustrations and Exhibits

Section 905.ILLUSTRATION E Septic Tanks

Section 905.EXHIBIT A Septic Tank with Slip-In Baffles

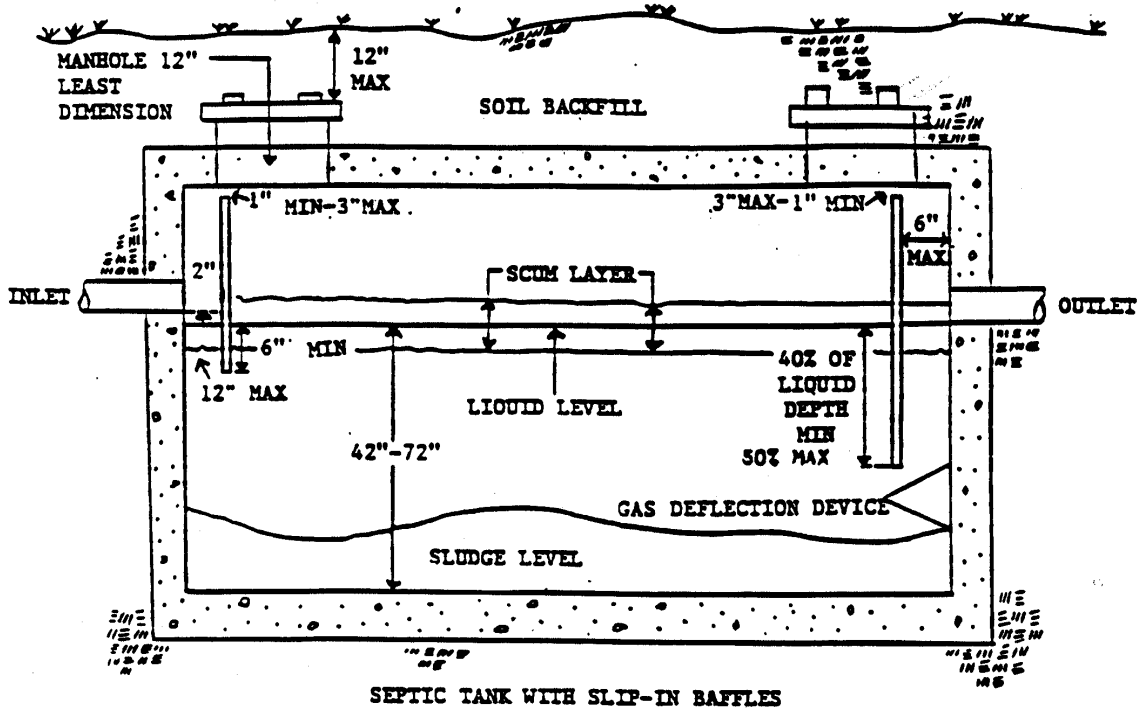

(Source: Amended at 20 Ill. Reg. 2431, effective March 15, 1996)

Section 905.APPENDIX A Illustrations and Exhibits

Section 905.ILLUSTRATION E Septic Tanks

Section 905.EXHIBIT B Septic Tank with T-Baffles

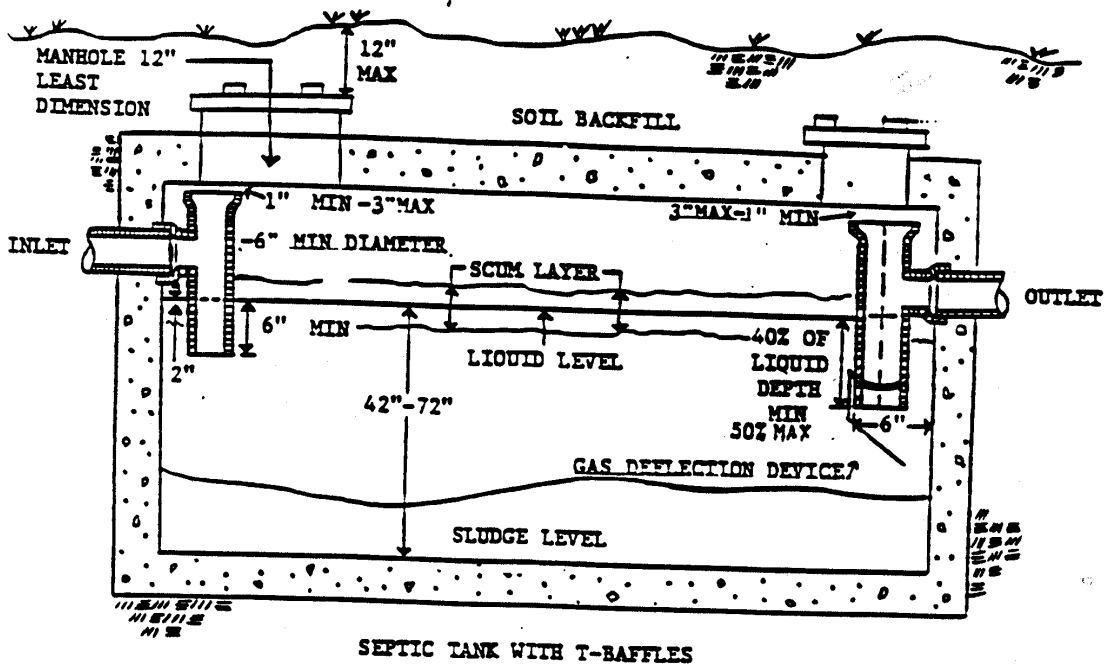

(Source: Amended at 20 Ill. Reg. 2431, effective March 15, 1996)

Section 905.APENDIX A Illustrations and Exhibits

Section 905.ILLUSTRATION E Septic Tanks

Section 905.EXHIBIT C Typical Gas Deflection Devices

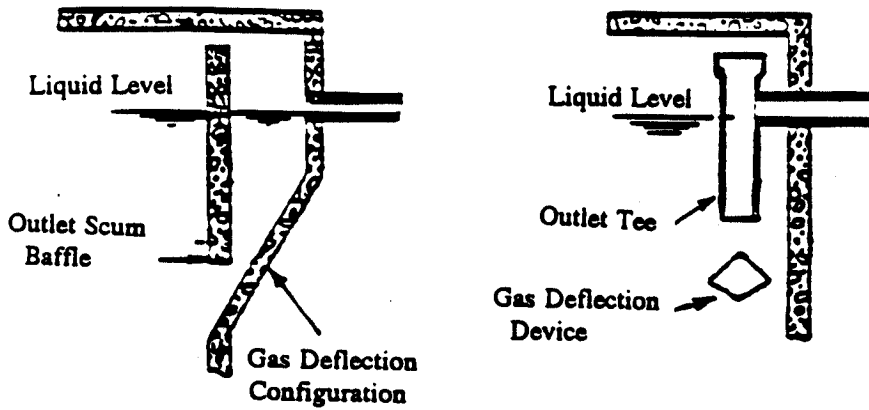
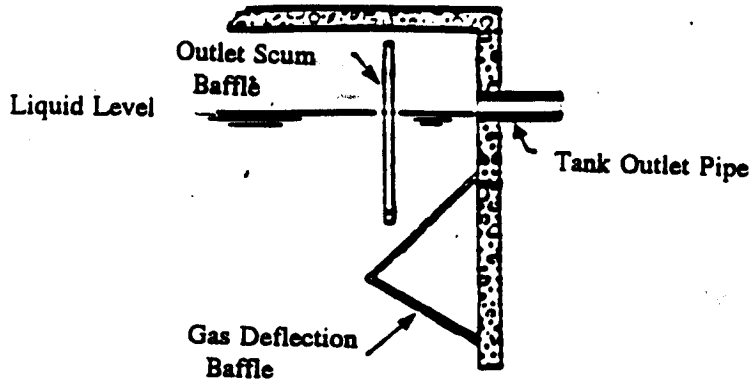

(Source: Added at 20 Ill. Reg. 2431, effective March 15, 1996)

**Section 905.APPENDIX A Illustrations and Exhibits**

**Section 905.ILLUSTRATION F Minimum Volumes for Septic Tanks Serving Residential Units**

---

NUMBER OF BEDROOMS	MINIMUM LIQUID CAPACITY OF TANK (GALLONS)	MINIMUM LIQUID CAPACITY OF TANK (GALLONS) WHEN GARBAGE GRINDER IS USED
2 or less	750	1125
3	1000	1500
4	1250	2000
5	1500	2200
6	1750	2600
7	2000	3000

---

(Source: Amended at 20 Ill. Reg. 2431, effective March 15, 1996)

**Section 905.APPENDIX A Illustrations and Exhibits**

**Section 905.ILLUSTRATION G Instructions for Conducting Percolation Tests**

Percolation tests shall not be made in frozen ground or ground that has been filled in the preceding 12 months. Percolation tests shall be performed in accordance with the following procedures:

1. Number and Location of Percolation Tests. Select an area where the seepage field will be located. When digging the holes, avoid animal burrows, large root channels, etc. At least 3 separate percolation tests shall be performed at the site of each proposed disposal area. The percolation test holes shall be at least 50 feet apart. At least one hole shall be located at the lowest elevation of the proposed absorption field area. The 2 holes with the highest results shall be used to determine percolation rate.
2. Depth of Percolation Test Hole. Dig or bore the holes with horizontal dimensions approximately 4 to 6 inches in diameter to the depth of the proposed seepage field or seepage bed.
3. Preparation of Test Hole.
  - a) Carefully pick the bottom and sides of the hole with a knife blade or sharp pointed instrument to remove smeared or smoothed soil and to provide a natural soil interface into which water may percolate.
  - b) Remove all loose material from the hole.
  - c) Add 2 inches of coarse gravel to protect the bottom from scouring and sediment. A removable hardware cloth screen to line the lower part of the hole also helps prevent sloughing of the hole sides during testing.
4. Saturation and Swelling of Soil: It is important to distinguish between saturation and swelling. Saturation means the void spaces between soil particles are full of water. This can be accomplished in a very short period of time. Swelling is caused by the intrusion of water into the individual soil particle. This is a slow process, especially in a clay type soil and is the reason for requiring a prolonged soaking period.
  - a) On the day prior to conducting the percolation test, carefully fill the hole with water and keep it full for at least 4 hours. The percolation test shall be conducted on the day following this presoaking at least 18 hours after presoaking is completed but prior to 30 hours after presoaking is completed. Cover the hole during this 18-30 hour waiting period. In sandy soils with greater than 70% sand and less than 15% clay (sand and loamy sand), after the 4 hour presoak, a percolation test may be attempted



77 ILLINOIS ADMINISTRATIVE CODE 905  
OCTOBER 2013

without the 18 hour waiting period. If the percolation test results are greater than 45 minutes for a 6 inch drop in water, the test must be repeated after the 18 hour waiting period. If the percolation test results are 45 minutes or less, the percolation rate shall be used to size the system.

- b) On the day of conducting the percolation test, carefully fill the hole with water to 12 inches above the gravel.
  - c) Allow the water level to drop to a point 6 inches above the gravel. If the water does not fall from 12 inches to 6 inches in 6 hours, the percolation test is terminated and an alternate system is required.
  - d) Measure the last 6 inch drop in water level at thirty minute intervals until all the water has seeped away. Warning: Under no conditions shall measurements be taken from water filled to the top of the hole or on water 12 inches deep in the hole. Such results are completely invalid and will not be accepted. Results from the last 6 inches of drop in water are the only results that will be accepted.
5. Recording of Results. Record results of all tests as the total minutes required for the last 6 inches of seepage. If the last 6 inches of water has not seeped away at the end of 6 hours, the soil must be considered unsuitable for seepage field disposal and the appropriate statement marked on the results form. If there is more than a 30 minute difference between the highest 2 percolation tests, use the larger result or perform additional percolation tests.
  6. Calculating the Percolation Rate. Add the total minutes required for the last 6 inches of water to fall from the 2 holes with the highest result and divide by 2. If the average is less than 60 minutes, use the percolation rate of 60 minutes. If the average is greater than 60 minutes, refer to Section 905.Appendix A: Illustration H of this Part. Locate in the first column (Time (minutes) required for last 6 inches of water to fall) where the highest 2 hole average fits and use the next highest result as the percolation rate for sizing and design. An example of this procedure is as follows: If 3 percolation tests are conducted with results of 120 minutes, 140 minutes, and 155 minutes, the highest 2 hole average would be  $(140 + 155)/2$  or 147.5 minutes. Looking at Section 905.Appendix A: Illustration H of this Part, the next highest result would be 150 minutes. The 150 minute rate would be used to size and design the subsurface seepage system.
  7. Distribution of Results. The results of the percolation tests shall be given to the homeowner and shall be retained by the contractor for at least 5 years. The percolation test data report shall be returned to the appropriate regional office or local authority.

TEST HOLE:

77 ILLINOIS ADMINISTRATIVE CODE 905

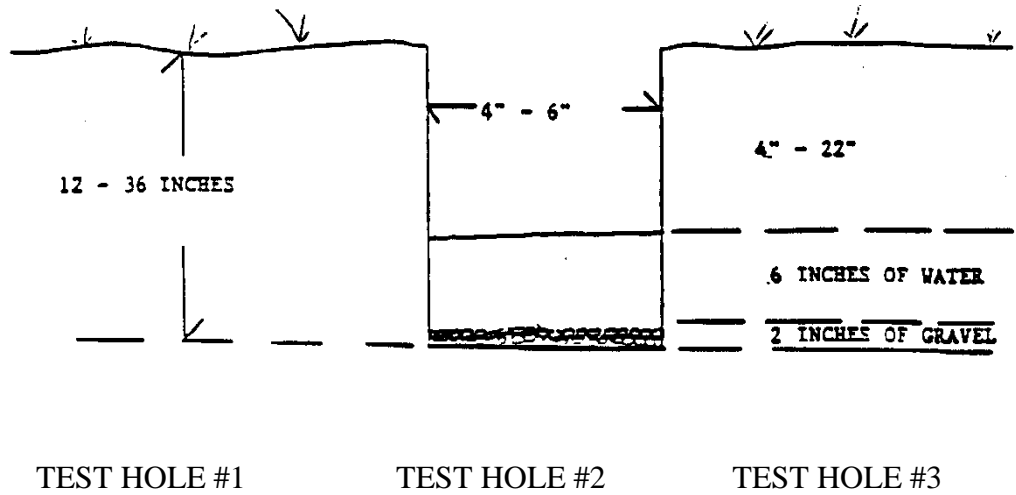

READING #	TIME (in min.)	WATER LEVEL (in inches)	TIME (in min.)	WATER LEVEL (in inches)	TIME (in min.)	WATER LEVEL (in inches)
1	0		0		0	
2	30		30		30	
3	60		60		60	
4	90		90		90	
5	120		120		120	
6	150		150		150	
7	180		180		180	
8	210		210		210	
9	240		240		240	
10	270		270		270	
11	300		300		300	
12	330		330		330	
13	360		360		360	

(Source: Amended at 20 Ill. Reg. 2431, effective March 15, 1996)

**Section 905.APPENDIX A Illustrations and Exhibits**

**Section 905.ILLUSTRATION H Subsurface Seepage System Size Determination**

**Section 905.EXHIBIT A Gravel System**

Time (minutes) required for last 6 inches of water to fall	FOR RESIDENTIAL USE Required Absorption Area (sq ft)/bedroom)	FOR INSTITUTIONAL OR COMMERCIAL USE Allowable application rate (GPD/sq ft) (5)	Recommended depth from bottom of the trench to the limiting layer
18 - 60	200	1.0	
90	210	.95	3 feet
120	235	.85	
150	265	.75	
180	290	.69	
240	320	.62	
300	350	.57	2 feet
360	385	.52	

NOTE:

1. Absorption area is figured as trench bottom area in absorption trenches and bottom area in seepage beds.
2. Seepage beds require 1½ times the seepage field absorption area specified.
3. Over 360 is unsuitable for subsurface seepage systems.
4. Under 18 is unsuitable for subsurface seepage systems.
5. Divide the required total gallons per day by this number to get the number of square feet required

(Source: Amended at 20 Ill. Reg. 2431, effective March 15, 1996)

**Section 905.APPENDIX A Illustrations and Exhibits**

**Section 905.ILLUSTRATION H Subsurface Seepage System Size Determination**

**Section 905.EXHIBIT B Gravelless System**

Time (minutes) required for last 6 inches of water to fall	FOR RESIDENTIAL USE Required Absorption Area (sq ft)/bedroom)		FOR INSTITUTIONAL OR COMMERCIAL USE Allowable application rate (GPD/sq ft) (5)		Recommended depth from bottom of the trench to the limiting layer
	8 inch	10 inch	8 inch	10 inch	
18 – 60	100	70	2.00	3.00	3 feet
90	105	70	1.90	2.86	
120	120	80	1.66	2.50	
150	135	90	1.48	2.22	
180	145	100	1.38	2.00	
240	160	110	1.25	1.82	2 feet
300	175	120	1.14	1.66	
360	195	130	1.0	1.54	

NOTE:

1. Over 360 is unsuitable for subsurface seepage systems.
2. Under 18 is unsuitable for subsurface seepage systems.
3. Divide the required total gallons per day by this number to get the number of lineal feet required.

(Source: Amended at 20 Ill. Reg. 2431, effective March 15, 1996)

**Section 905.APPENDIX A Illustrations and Exhibits**

**Section 905.ILLUSTRATION I Seepage Field Construction**

**Section 905.EXHIBIT D Spacing – Gravelless and Chamber Systems**

SPACING FOR SEEPAGE FIELD CONSTRUCTION  
(GRAVELLESS AND CHAMBER SYSTEMS)

---

Gravelless and Chamber Dimensions	Minimum Center to Center Spacing of Distribution Lines
8 Inch Inside Diameter of Gravelless Pipe System	7.0 feet
10 Inch Inside Diameter of Gravelless Pipe System	7.0 feet
12 Inch Wide Chamber System	7.0 feet
18 Inch Wide or Wider Chamber System	9.0 feet

---

(Source: Amended at 37 Ill. Reg. 14994, effective August 28, 2013)

**Section 905.APPENDIX A Illustrations and Exhibits**

**Section 905.ILLUSTRATION I Seepage Field Construction**

**Section 905.EXHIBIT E Chamber Sizing Requirements**

Example: Chamber systems shall be sized on the absorption area of the chamber that is equivalent to the bottom area of a gravel system. The equivalent chamber absorption area per lineal foot is equal to the average inside width of the chamber times an equivalency factor of 2.5. For example, a chamber that has an average inside width of 1.25 feet provides an equivalent absorption area of 3.125 square feet per lineal foot. (1.25 feet times the 2.5 equivalency factor equals 3.125 square feet per lineal foot.)

To determine the length of chambers required, first calculate the absorption area required for a gravel system based on Appendix A, Illustration H, Exhibit A or Appendix A, Illustration M, Exhibit A. Then divide this area by the equivalent chamber absorption area per lineal foot. For example, if a 3 bedroom house requires 870 square feet of absorption field and chambers 1.25 feet wide are being used, then the length of chambers needed is 278 feet. (870 square feet divided by 3.125 square feet per lineal foot equals 278 feet.)

Chamber systems with an average inside dimension equal to or greater than 20 inches shall not be designed to receive an equivalent absorption area of greater than 5square feet per lineal foot.

(Source: Amended at 37 Ill. Reg. 14994, effective August 28, 2013)

**Section 905.APPENDIX A Illustrations and Exhibits**

**Section 905.ILLUSTRATION J Septic Tank Subsurface Seepage Field**

**Section 905.EXHIBIT C Plan View – Gravelless and Chamber System**

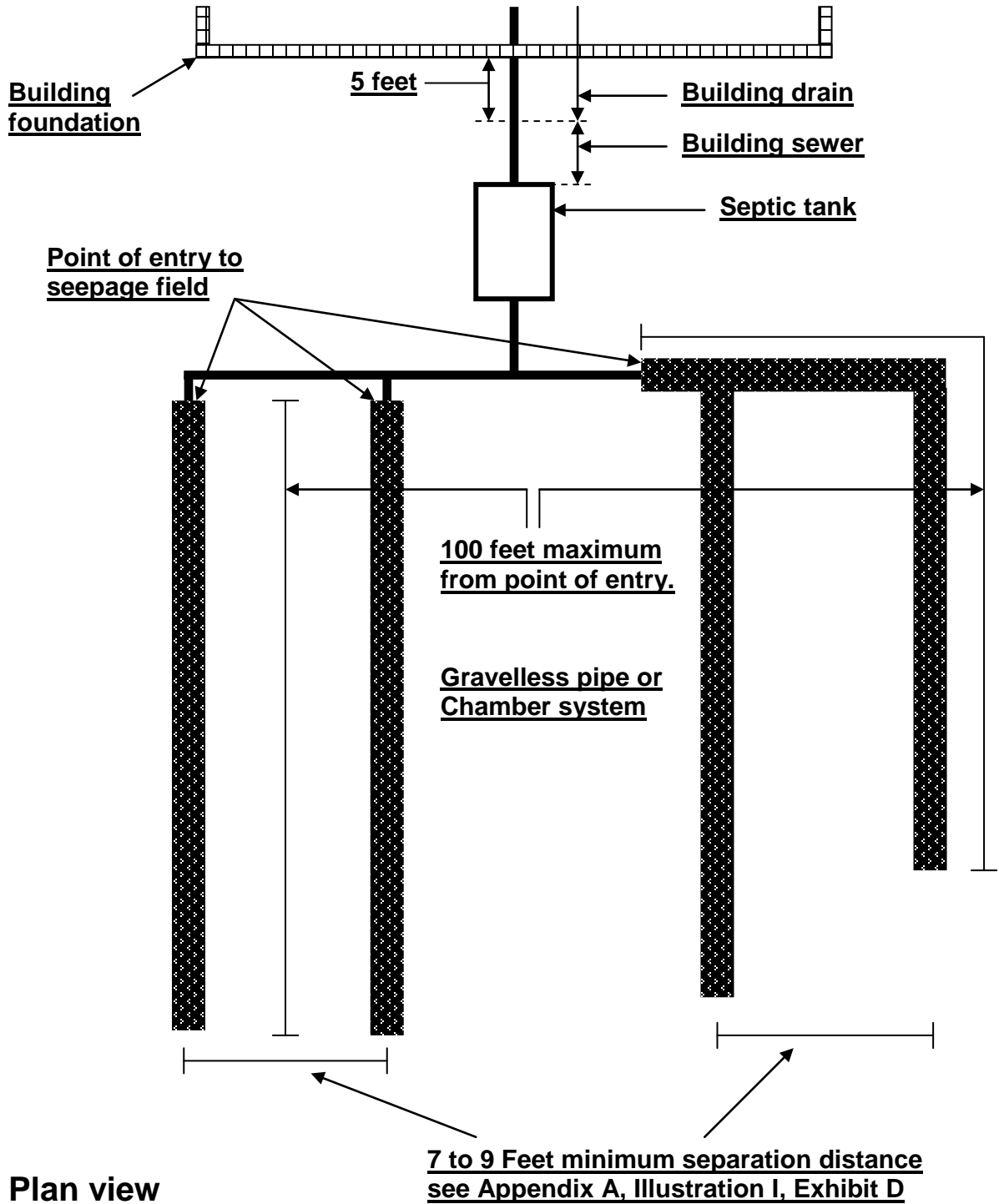

**Plan view**  
(Source: Amended at 37 Ill. Reg. 14994, effective August 28, 2013)

**Section 905.APPENDIX A Illustrations and Exhibits**

**Section 905.ILLUSTRATION J Septic Tank Subsurface Seepage Field**

**Section 905.EXHIBIT D Section View – Gravelless and Chamber System**

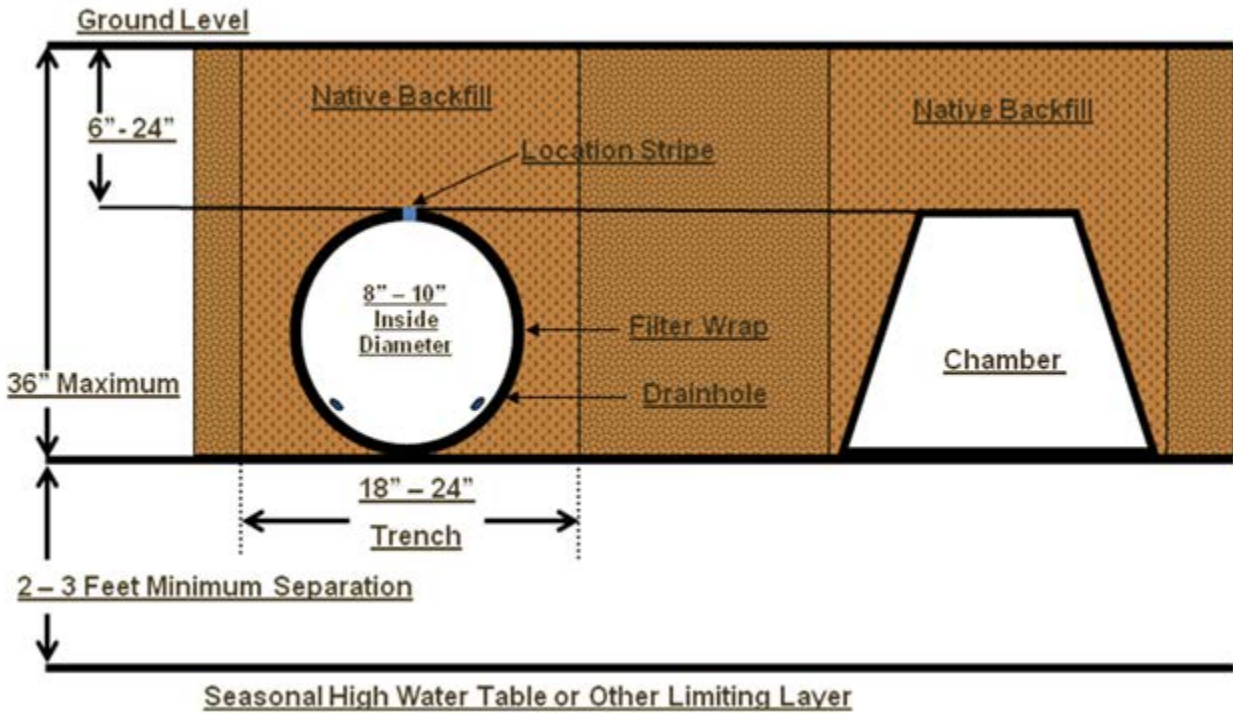

(Source: Amended at 37 Ill. Reg. 14994, effective August 28, 2013)



**Section 905.APPENDIX A Illustrations and Exhibits**

**Section 905.ILLUSTRATION K Serial Distribution**

**Section 905.EXHIBIT A Plan View #1 – Gravel System**

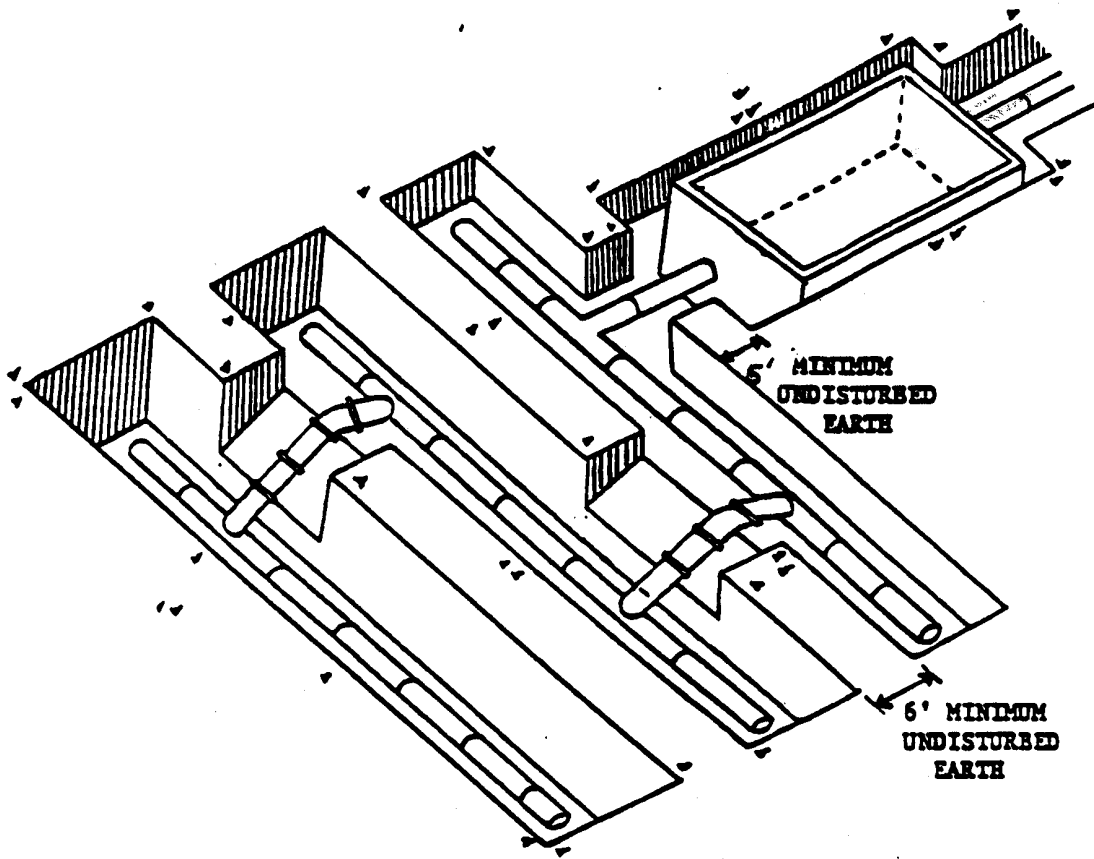

(Source: Amended at 20 Ill. Reg. 2431, effective March 15, 1996)

Section 905.APPENDIX A Illustrations and Exhibits

Section 905.ILLUSTRATION K Serial Distribution

Section 905.EXHIBIT B Section View #1 - Gravel System

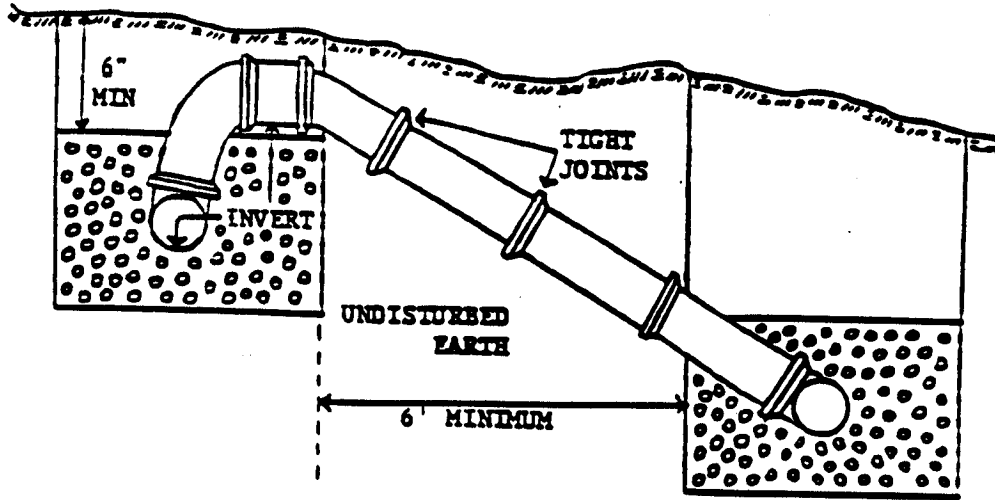

NOTE: Invert of the first relief line must be at least 1 inch lower than invert of the septic tank outlets.

(Source: Amended at 20 Ill. Reg. 2431, effective March 15, 1996)

Section 905.APPENDIX A Illustrations and Exhibits

Section 905.ILLUSTRATION K Serial Distribution

Section 905.EXHIBIT C Plan View #2 - Gravel System

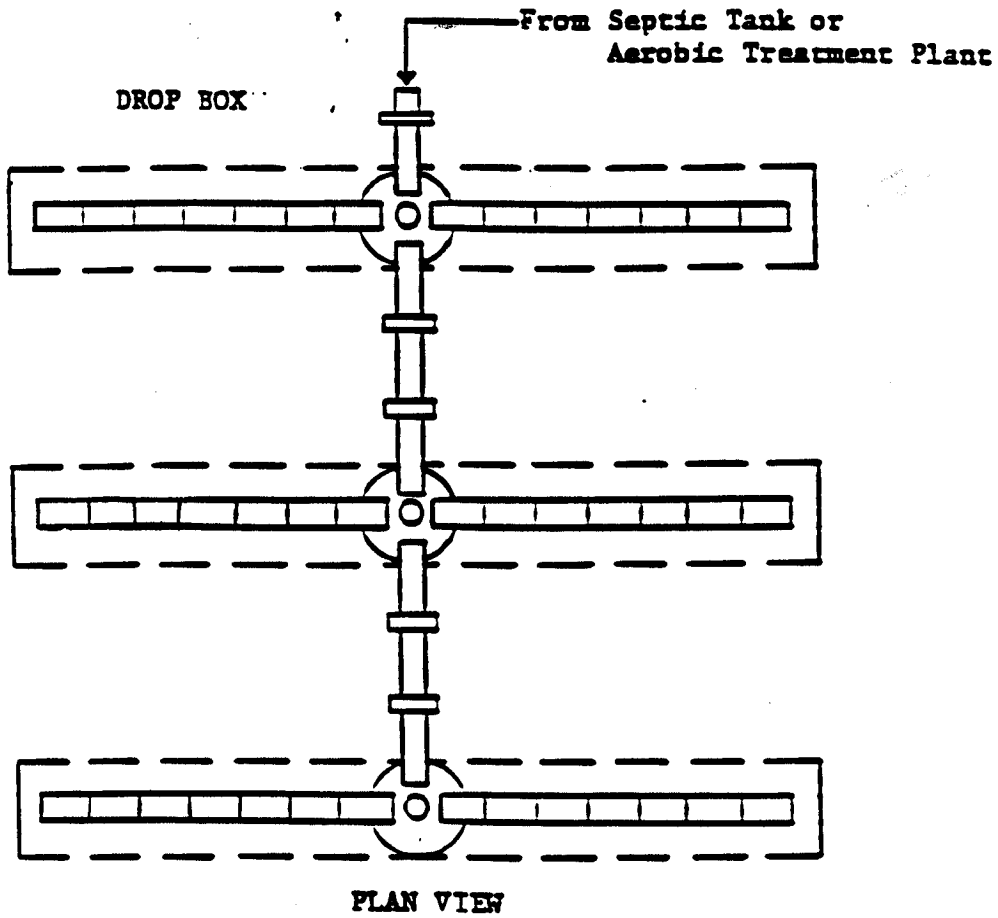

(Source: Amended at 20 Ill. Reg. 2431, effective March 15, 1996)

Section 905.APPENDIX A Illustrations and Exhibits

Section 905.ILLUSTRATION K Serial Distribution

Section 905.EXHIBIT D Section View #2 – Gravel System

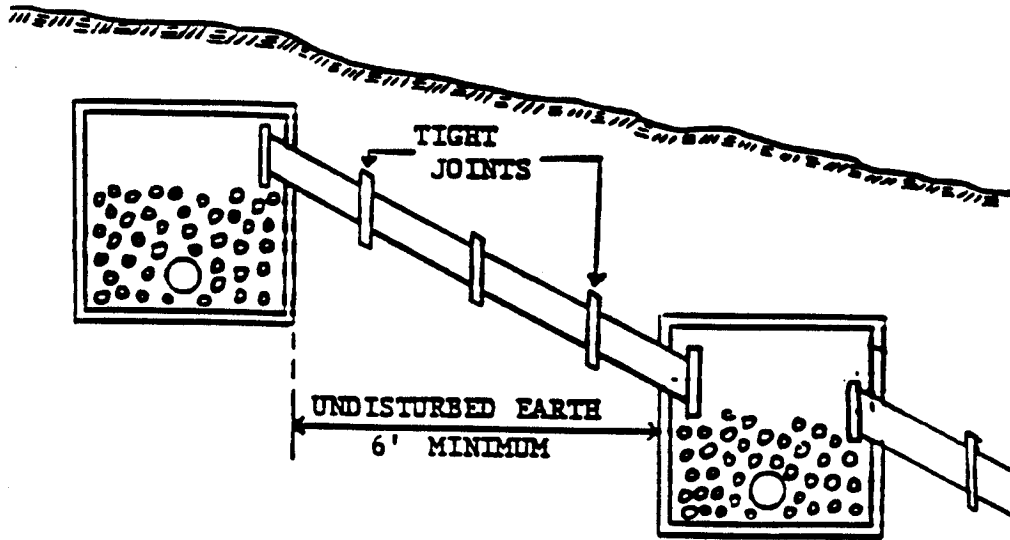

\*\* Differing ground slopes over subsurface disposal fields may require use of various combinations of fittings.

(Source: Amended at 20 Ill. Reg. 2431, effective March 15, 1996)

**Section 905.APPENDIX A Illustrations and Exhibits**

**Section 905.ILLUSTRATION K Serial Distribution**

**Section 905.EXHIBIT E Plan View #1 – Gravelless System**

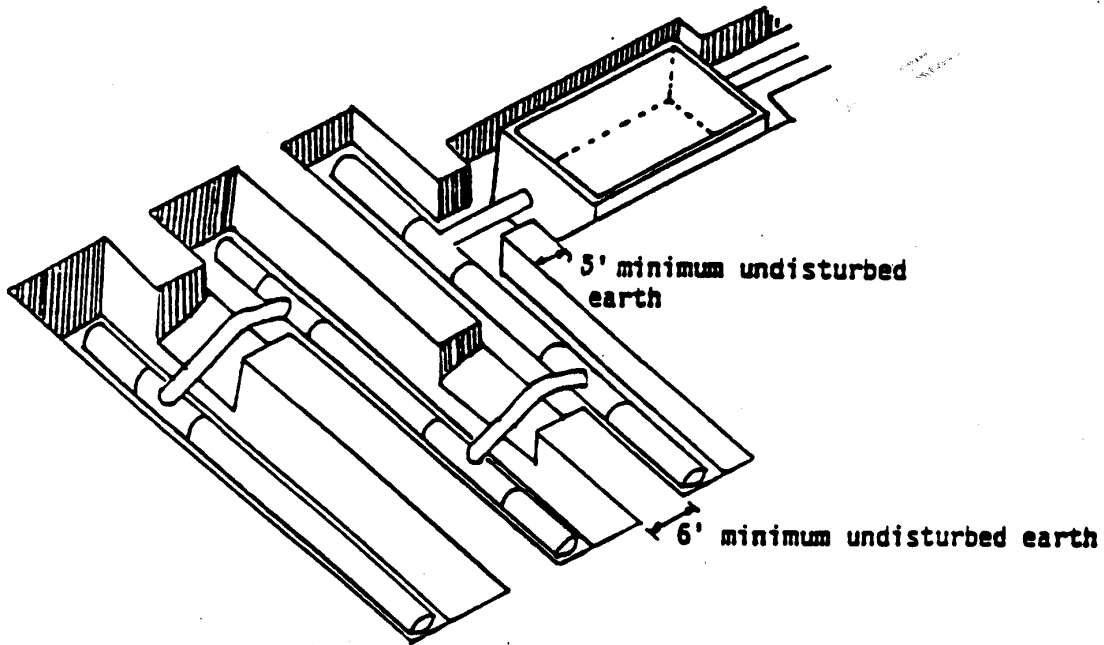

(Source: Amended at 20 Ill. Reg. 2431, effective March 15, 1996)

**Section 905.APPENDIX A Illustrations and Exhibits**

**Section 905.ILLUSTRATION K Serial Distribution**

**Section 905.EXHIBIT F Section View #1 – Gravelless System**

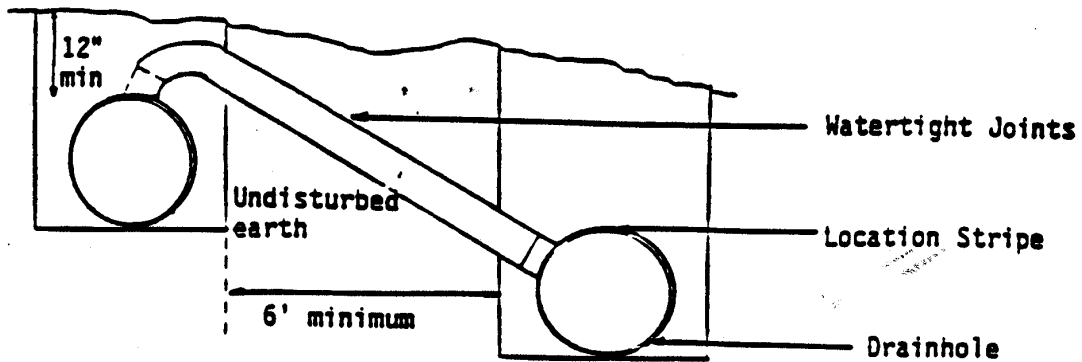

NOTE: Invert of the septic tank outlet shall be at least one inch higher than the top of the gravelless pipe.

(Source: Amended at 20 Ill. Reg. 2431, effective March 15, 1996)

Section 905.APPENDIX A Illustrations and Exhibits

Section 905.ILLUSTRATION K Serial Distribution

Section 905.EXHIBIT G Plan View #2 – Gravelless System

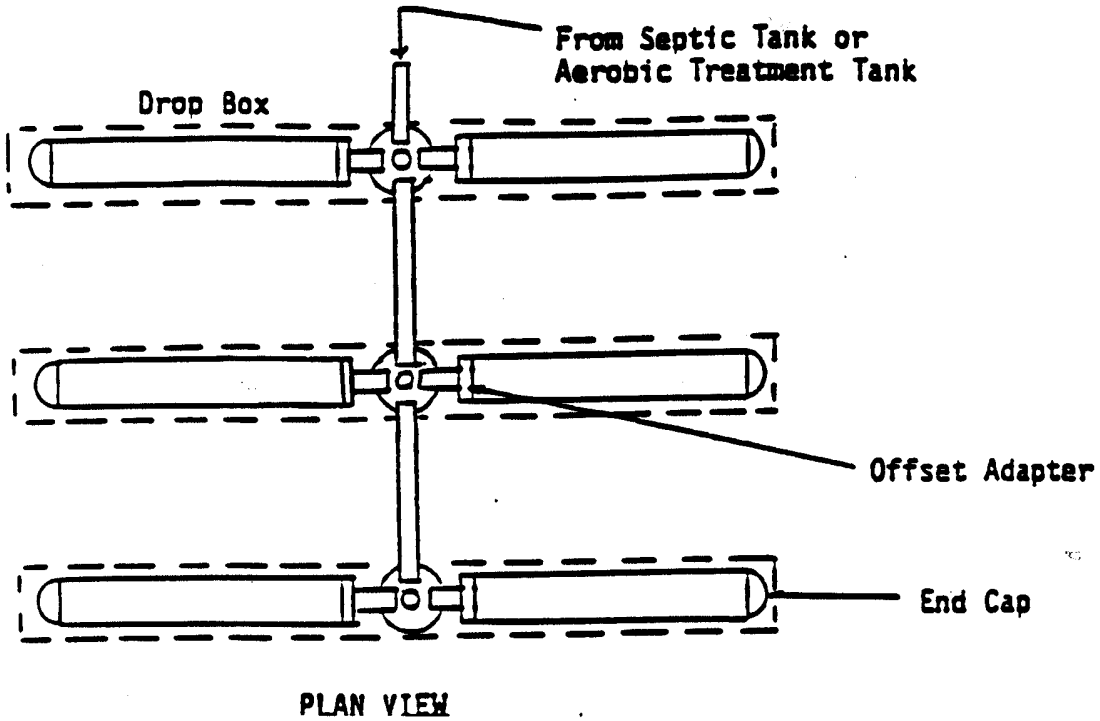

(Source: Amended at 20 Ill. Reg. 2431, effective March 15, 1996)

**Section 905.APPENDIX A Illustrations and Exhibits**

**Section 905.ILLUSTRATION K Serial Distribution**

**Section 905.EXHIBIT H Section View #2 – Gravelless System**

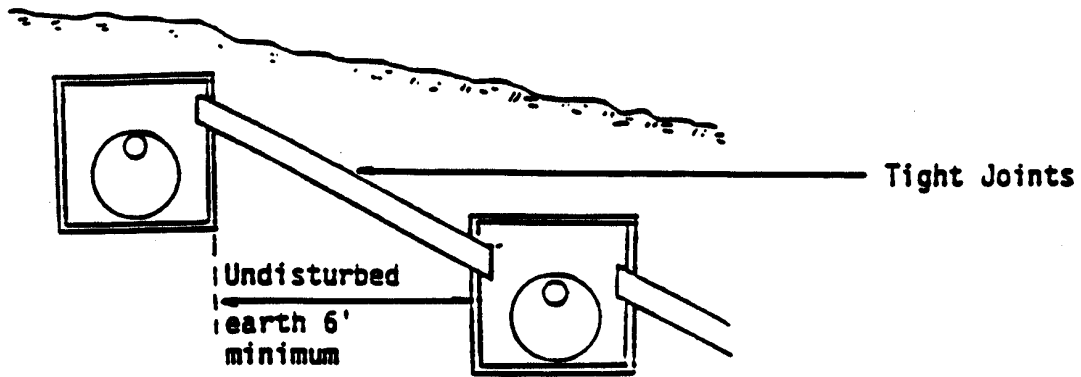

(Source: Amended at 20 Ill. Reg. 2431, effective March 15, 1996)



**Section 905.APPENDIX A Illustrations and Exhibits**

**Section 905.ILLUSTRATION L Seepage Bed**

**Section 905.EXHIBIT C End View**

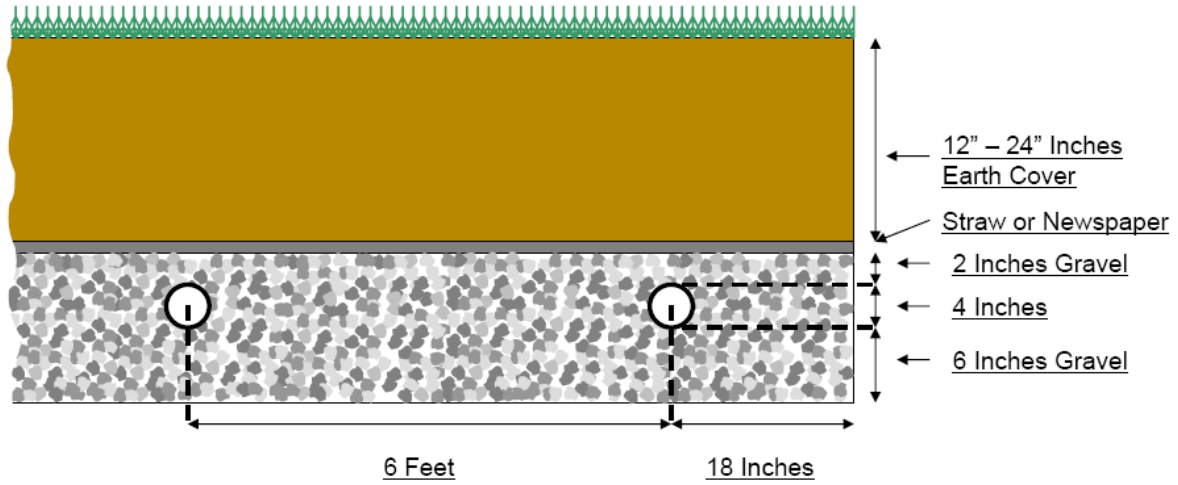

---

(Source: Amended at 37 Ill. Reg. 14994, effective August 28, 2013)

**Section 905.APPENDIX A Illustrations and Exhibits**

**Section 905.ILLUSTRATION M Soil Suitability for On-Site Sewage Design**

**Section 905.EXHIBIT A Loading Rates in Square Feet Per Bedroom and Gallons/Square Feet/Day**

Design Group	Soil Group (Most Limiting Layer)	Minimum Separation To Limiting Layer <sup>1</sup>	Permeability Range	Size of System	
				Residential Reg. Absorption (ft <sup>2</sup> /bedroom)	Institutional/Commercial Allowable Application Rate (GPD/ft <sup>2</sup> )
I	1A	NR <sup>3</sup>	Very Rapid	NR <sup>3</sup>	NR <sup>3</sup>
II	2A; 2B; 2K	3 feet	Rapid	200	1.0
III	3B; 3K	3 feet	High Moderately Rapid	220	0.91
IV	3A; 3L; 4D; 4K	3 feet	Low Moderately Rapid	240	0.84
V	4A;; 4B; 4H; 4L; 5D	3 feet	Very High Moderate	265	0.75
VI	4F; 4M; 5B	3 feet	High Moderate	290	0.69
VII	4N; 5A; 5C; 5H; 5K; 6D	2 feet	Moderate	325	0.62
VIII	4O; 5E; 5I; 5L; 6A; 6B; 6E; 6H; 6K	2 feet	Low Moderate	385	0.52
IX <sup>2</sup>	5F; 5M; 6C; 6L; 7D; 7F	2 feet	High Moderately Slow	445	0.45
X <sup>2</sup>	5G; 6F; 6I; 7E; 7C; 7H	2 feet	Low Moderately Slow	500	0.40
XI <sup>2</sup>	5N; 6G; 6J; 6M; 7F; 7I	2 feet	Slow	740	0.27
XII <sup>2</sup>	7G; 7J; 7L; 8E; 8I	2 feet	Very Slow	1000	0.20
XII <sup>2</sup>	5O; 6N; 6O; 7M; 7N; 7O; 8J; 8M; 8O	NR <sup>3</sup>	NR <sup>3</sup>	NR <sup>3</sup>	0.00
XIII	9	<b>SUBSURFACE DISPOSAL NOT RECOMMENDED</b>			

NOTES:

<sup>1</sup> Limiting layers include fragipans; bedrock; compact glacial tills; seasonal high water table or other soil profile features that will materially affect the absorption of liquid from the disposal field.

77 ILLINOIS ADMINISTRATIVE CODE 905  
OCTOBER 2013

<sup>2</sup> Soils in this group are less than the minimum percolation rate established in Appendix A, Illustration H as suitable for subsurface seepage systems.

<sup>3</sup> NR = Subsurface disposal system not recommended.

(Source: Amended at 37 Ill. Reg. 14994, effective August 28, 2013)

77 ILLINOIS ADMINISTRATIVE CODE 905  
OCTOBER 2013

**Section 905.APPENDIX A Illustrations and Exhibits**

**Section 905.ILLUSTRATION M Soil Suitability for On-Site Sewage Design**

**Section 905.EXHIBIT B Key for Determining Sewage Loading Rates (Gallons/Square Foot/Day)**

Structure and Parent Material	Single grain; Weak; Platy <sup>2</sup>	Granular, Angular and Subangular Blocky; Prismatic									Structureless or Massive				
		Loess: Outwash; Alluvium; Lacustrine <sup>8</sup>						Till <sup>3</sup>			Loess; Outwash; Alluvium; Lacustrine <sup>8</sup>			Till <sup>3</sup>	
		Week		Moderate; Strong		Strong		Moderate; Strong			Loess; Outwash; Alluvium; Lacustrine <sup>8</sup>			Till <sup>3</sup>	
Moist Consistence	lo vfr fr	vfr fr	fi	vfr	fi	vfr fr	fi	fr	fi	vfi	vfr	fr	fi	vfr fr	fi vfi
Texture	A	B	C	D	E	F	G	H	I	J	K	L	M	N	O
1. Fragmental; Ext. or Very gravelly sand	> 1.00 <sup>4</sup>	N/A <sup>5</sup>	N/A	N/A	N/A	N/A	N/A	N/A	N/A	N/A	N/A	N/A	N/A	N/A	N/A
2. Sand; Loamy course sand; Loamy sand; Gravelly sand; Coarse sand; Gravelly loamy sand	1.00	1.00	N/A	N/A	N/A	N/A	N/A	N/A	N/A	N/A	1.00	N/A	N/A	N/A	N/A
3. Fine sand; Loamy fine sand; Coarse sandy loam	0.84	0.91	N/A	N/A	N/A	N/A	N/A	N/A	N/A	N/A	0.91	0.84	N/A	N/A	N/A
4. Sandy loam; Fine sandy loam; Gravelly sandy loam; Gravelly loam; Gravelly silt loam	0.75	0.75	N/A	0.84	N/A	0.69	N/A	N/A	0.75	N/A	0.84	0.75	0.69	0.62	0.52
5. Loam; Silt loam; Very fine sandy loam; Sandy clay loam; Silt; Very fine sand; Loamy very fine sand; Gravelly clay loam	0.62	0.69	0.62	0.75	0.52	0.45 <sup>6</sup>	0.40 <sup>6</sup>	0.62	0.52	N/A	0.62	0.52	0.45 <sup>6</sup>	0.27 <sup>6</sup>	N/R <sup>7</sup>
6. Silty clay loam (<35% c); Clay loam (< 35% c)	.052	0.52	0.45 <sup>6</sup>	0.62	0.52	0.40 <sup>8</sup>	0.27 <sup>6</sup>	0.52	0.40 <sup>6</sup>	0.27 <sup>6</sup>	0.52	0.45 <sup>6</sup>	0.27 <sup>6</sup>	N/R	N/R
7. Silty clay loam (>35% c); Clay loam (>35% c)	N/A	N/A	0.40 <sup>6</sup>	0.45 <sup>6</sup>	0.40 <sup>6</sup>	0.27 <sup>6</sup>	0.20 <sup>6</sup>	0.40 <sup>6</sup>	0.27 <sup>6</sup>	0.20 <sup>6</sup>	N/A	0.20 <sup>6</sup>	N/R	N/R	N/R
8. Sandy clay; Clay	N/A	N/A	N/A	N/A	0.20 <sup>6,9</sup>	N/A	N/A	N/A	0.20 <sup>6,9</sup>	N/R	N/A	N/A	N/R	N/A	N/R
9. Organics; Fragic; Lithic; Paralithic	—SOIL PROPERTIES HAVE VERY SEVERE LIMITATIONS; SUBSURFACE DISPOSAL NOT RECOMMENDED—														

FOOTNOTES:

- <sup>1</sup> Disturbed soils are highly variable and require special on-site investigations.
- <sup>2</sup> Moderate or strong platy structure for the soil textures in Groups 4, 5 and 6 have a loading rate of 0.40 g/sq.ft/d. Platy structure having firm or very firm consistency or caused by mechanical compaction has a loading rate of 0.0 g/sq.ft/d.
- <sup>3</sup> Basal glacial tills structured by geogenic processes have the same loading rates as structureless glacial till.
- <sup>4</sup> This soil group is estimated to have very rapid permeability and exceeds the maximum established rate in Illustration H, Exhibit A.
- <sup>5</sup> N/A means not applicable.
- <sup>6</sup> These soil groups are estimated to have moderately slow to very slow permeability and are less than the minimum established rate in Illustration H, Exhibit A.
- <sup>7</sup> N/R means not recommended. These soils have loading rates considered too low for conventional subsurface disposal.
- <sup>8</sup> In some areas, lacustrine material may have physical properties similar to glacial till and should be placed in the glacial till columns.
- <sup>9</sup> Non-swelling (1:1 lattice) clays formed in bedrock residuum have a loading rate of 0.27 g/sq.ft/d. Swelling (2:1 lattice) clays are not recommended for subsurface disposal.

(Source: Amended at 37 Ill. Reg. 14994, effective August 28, 2013)

**Section 905.APPENDIX A Illustrations and Exhibits**

**Section 905.ILLUSTRATION N Buried Sand Filter**

**Section 905.EXHIBIT A Plan View**

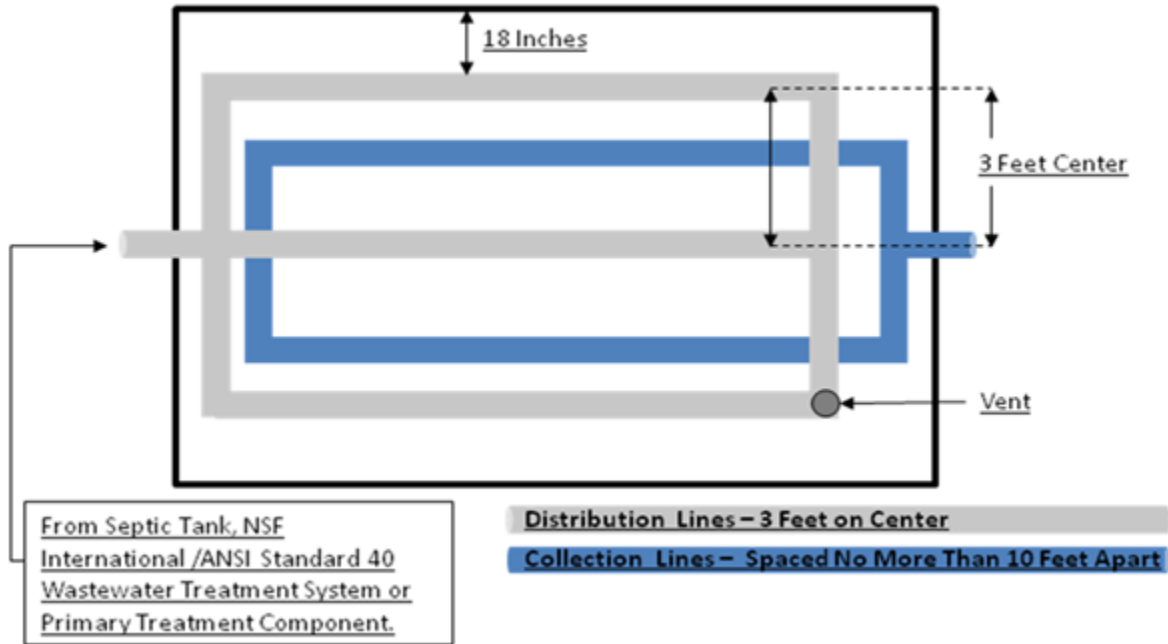

(Source: Amended at 37 Ill. Reg. 14994, effective August 28, 2013)

**Section 905.APPENDIX A Illustrations and Exhibits**

**Section 905.ILLUSTRATION N Buried Sand Filter**

**Section 905.EXHIBIT B Section View**

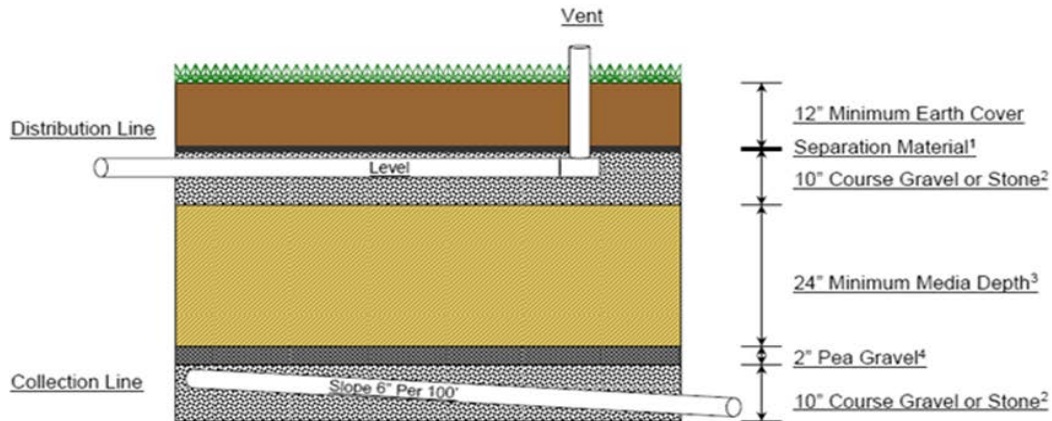

- 1 Separation materials to support the backfill: straw, newspaper, untreated building paper, geotextile fabric or other permeable or biodegradable material.
- 2 Course Gravel or Stone: 3/4" to 2 1/2" diameter.
- 3 Sand Filter Media: The sand shall have an effective size of 0.5 to 2.0 millimeters and a uniformity coefficient of less than 3.5.
- 4 Pea Gravel: 1/8" to 3/8" diameter.

(Source: Amended at 37 Ill. Reg. 14994, effective August 28, 2013)

**Section 905.APPENDIX A Illustrations and Exhibits**

**Section 905.ILLUSTRATION N Buried Sand Filter**

**Section 905.EXHIBIT C End View**

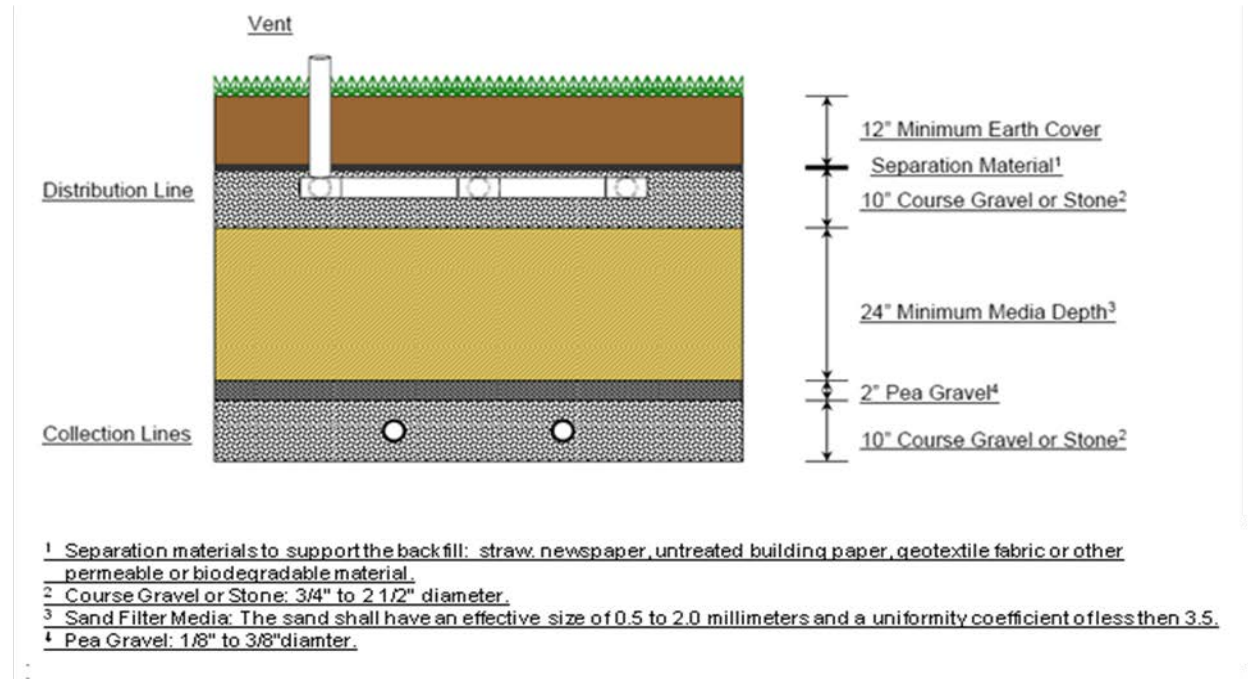

(Source: Amended at 37 Ill. Reg. 14994, effective August 28, 2013)



Section 905.APPENDIX A Illustrations and Exhibits

Section 905.ILLUSTRATION O Recirculating Sand Filter System

Section 905.EXHIBIT A System Diagram

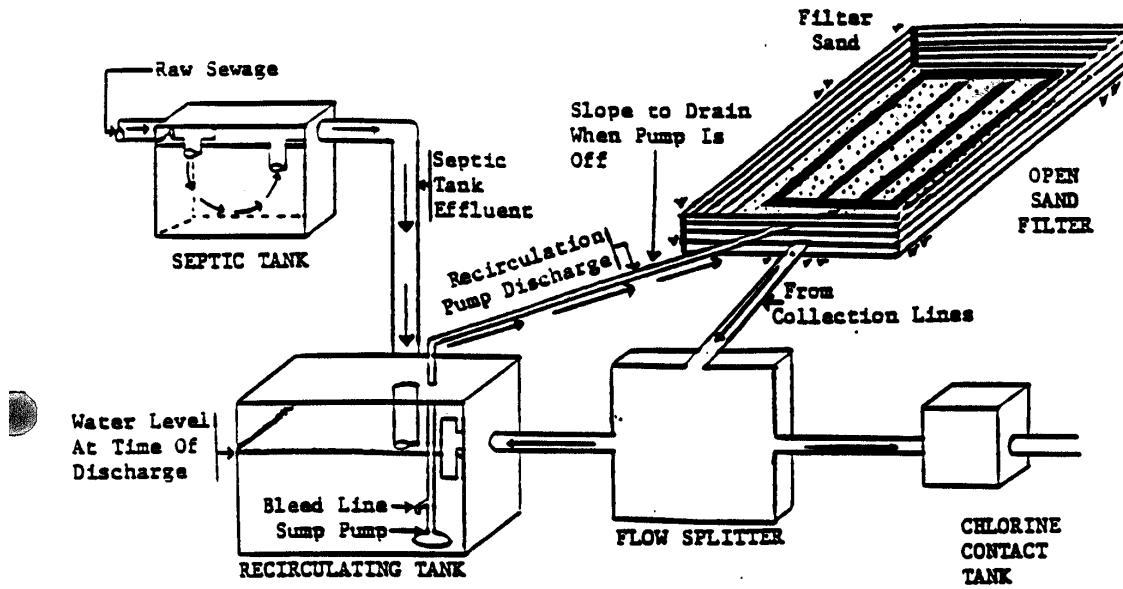

(Source: Amended at 20 Ill. Reg. 2431, effective March 15, 1996)

**Section 905.APPENDIX A Illustrations and Exhibits**

**Section 905.ILLUSTRATION O Recirculating Sand Filter System**

**Section 905.EXHIBIT B Flow Splitter Detail**

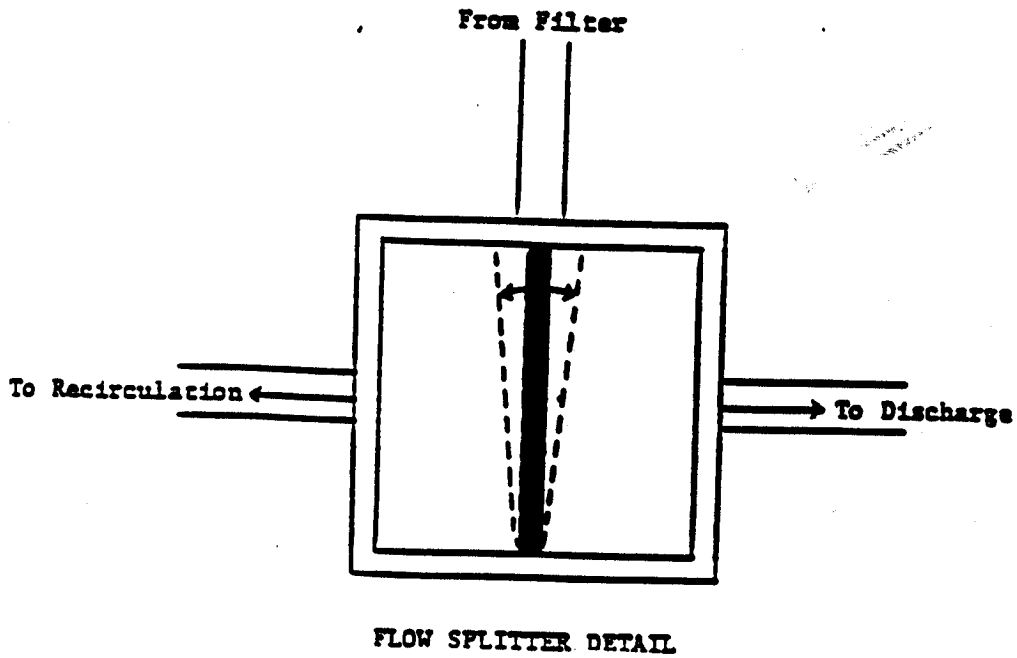

(Source: Amended at 20 Ill. Reg. 2431, effective March 15, 1996)

**Section 905.APPENDIX A Illustrations and Exhibits**

**Section ILLUSTRATION P Recirculating Sand Filter Sizing Chart**

NUMBER OF BED-ROOMS	SEWAGE FLOW PER DAY (Gal.)	SEPTIC TANK SIZE (Gal.) No Garbage Grinder	RECIRCULATION TANK SIZE (Gal.)	AREA OF SAND FILTER (Sq. ft.)	RECOMMENDED SIZED OF SAND FILTER	NUMBER OF UNDER-DRAINS	NUMBER OF DISTRIBUTION PIPES
1	200	750	500	100	10' x 10'	1	3
2	400	750	500	133	11' x 12'	1	3
3	600	1,000	500	200	14' x 14'	1	4
4	800	1,250	500	266	16' x 17'	1	5
5	1,000	1,500	500	333	18' x 19'	2	6
6	1,200	1,750	500	400	20' x 20'	2	6
7	1,400	2,000	500	466	20' x 23'	2	6
8	1,500	2,250	500	500	20' x 25'	2	6

(Source: Amended at 20 Ill. Reg. 2431, effective March 15, 1996)

Section 905.APPENDIX A Illustrations and Exhibits

Section 905.ILLUSTRATION Q Recirculating Tank Pump Control

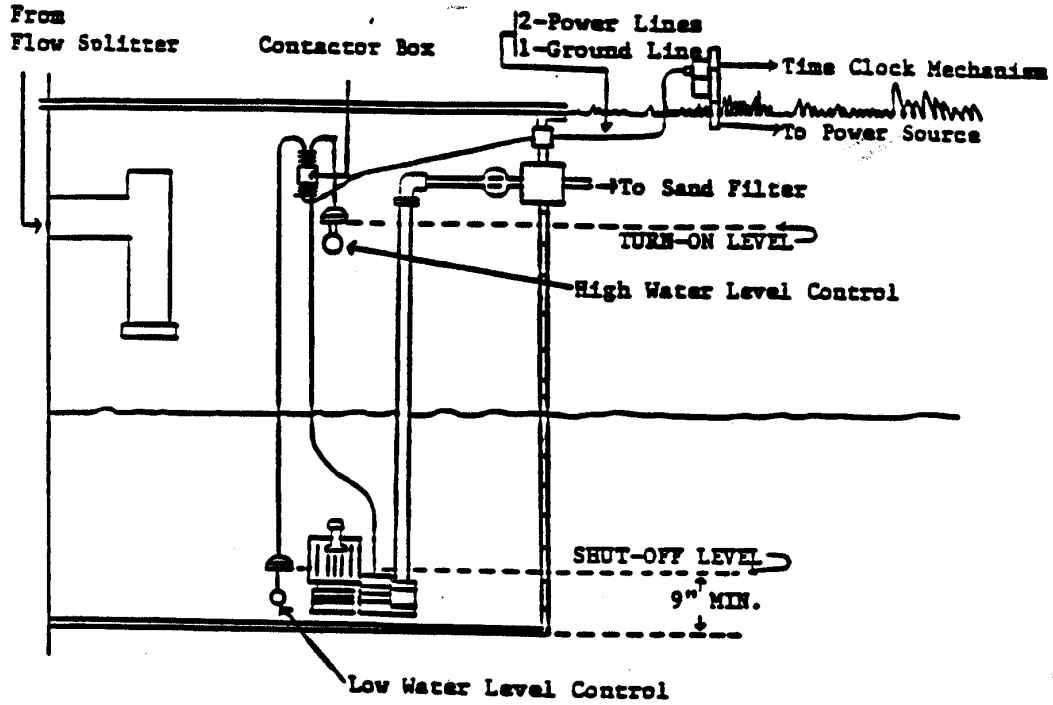

(Source: Amended at 20 Ill. Reg. 2431, effective March 15, 1996)

Section 905.APPENDIX A Illustrations and Exhibits

Section 905.ILLUSTRATION R Waste Stabilization Pond

Section 905.EXHIBIT A Plan View

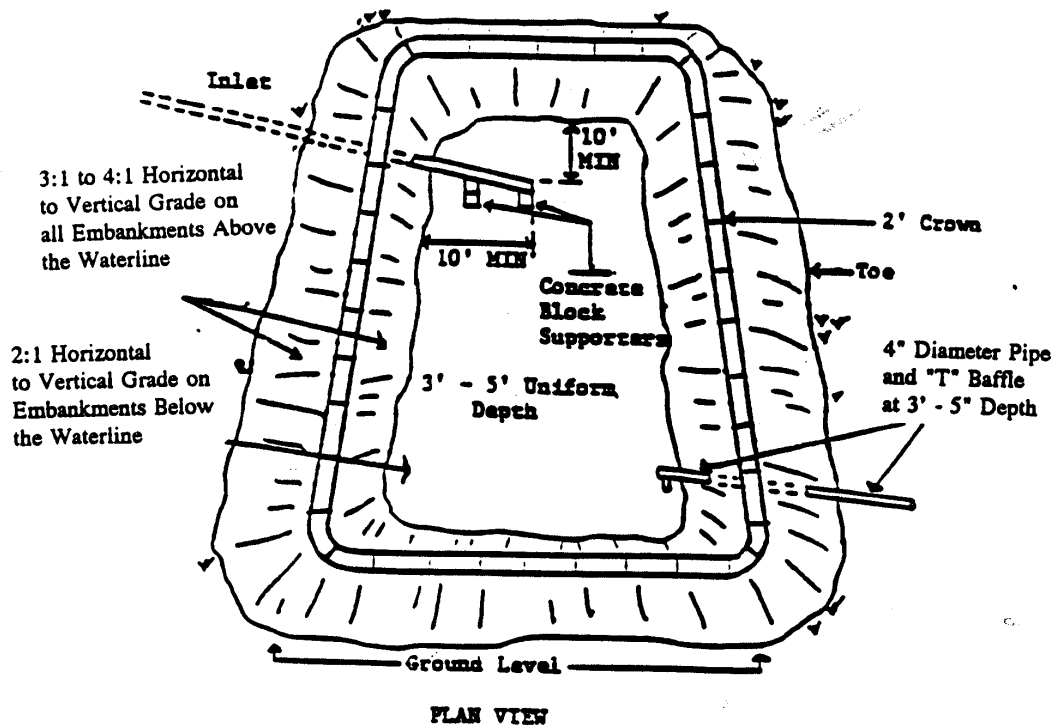

(Source: Amended at 20 Ill. Reg. 2431, effective March 15, 1996)

Section 905.APPENDIX A Illustrations and Exhibits

Section 905.ILLUSTRATION R Waste Stabilization Pond

Section 905.EXHIBIT B Section View

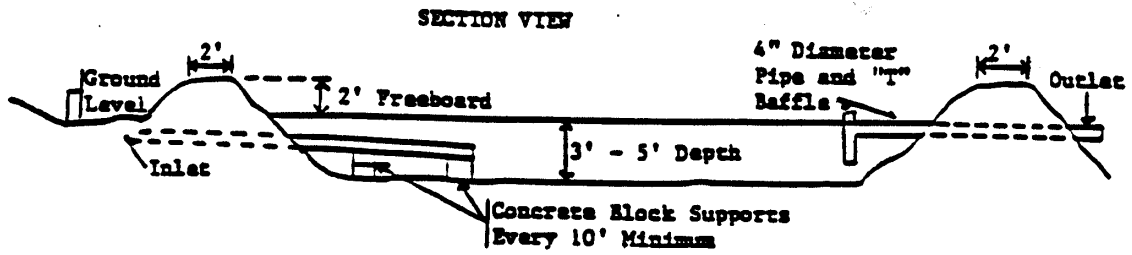

(Source: Amended at 20 Ill. Reg. 2431, effective March 15, 1996)

**Section 905.APPENDIX A Illustrations and Exhibits**

**Section 905.ILLUSTRATION R Waste Stabilization Pond**

**Section 905.EXHIBIT C Waste Stabilization Pond Surface Area in Square Feet**

Bedrooms	Depth – 3 ft.	With Septic Tank			With Aeration		
		4ft.	5ft.		3ft.	4ft.	5ft.
1	533 $\frac{1}{3}$	400	320		160	120	96
2	1067	800	640		320	240	192
3	1600	1200	960		480	360	288
4	2133	1600	1280		640	480	384
5	2667	2000	1600		800	600	480
6	3200	2400	1920		960	720	576
7	3733	2800	2240		1120	840	672

(Source: Added at 20 Ill. Reg. 2431, effective March 15, 1996)

**Section 905.APPENDIX A Illustrations and Exhibits**

**Section 905.ILLUSTRATION S Chlorine Contact Tank**

**Section 905.EXHIBIT A Minimum Required Chlorine Contact Tank Volume**

AVERAGE FLOW RATE GPD	MINIMUM REQUIRED VOLUME GALLONS
100	30
200	30
300	30
400	30
500	30
600	30
700	36
800	42
900	47
1000	52
1100	57
1200	63
1300	68
1400	73
1500	78



Section 905.APPENDIX A Illustrations and Exhibits

Section 905.ILLUSTRATION S Chlorine Contact Tank

Section 905.EXHIBIT B Chlorine Feeder, Contact Tank, and Sampling Port

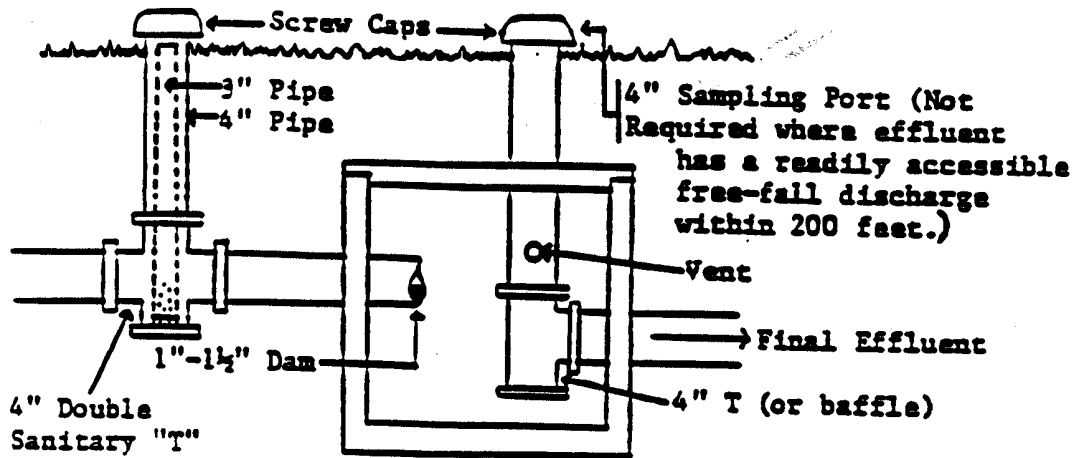

(Source: Amended at 20 Ill. Reg. 2431, effective March 15, 1996)

Section 905.APPENDIX A Illustrations and Exhibits

Section 905.ILLUSTRATION T Sanitary and Concrete Vault Privy

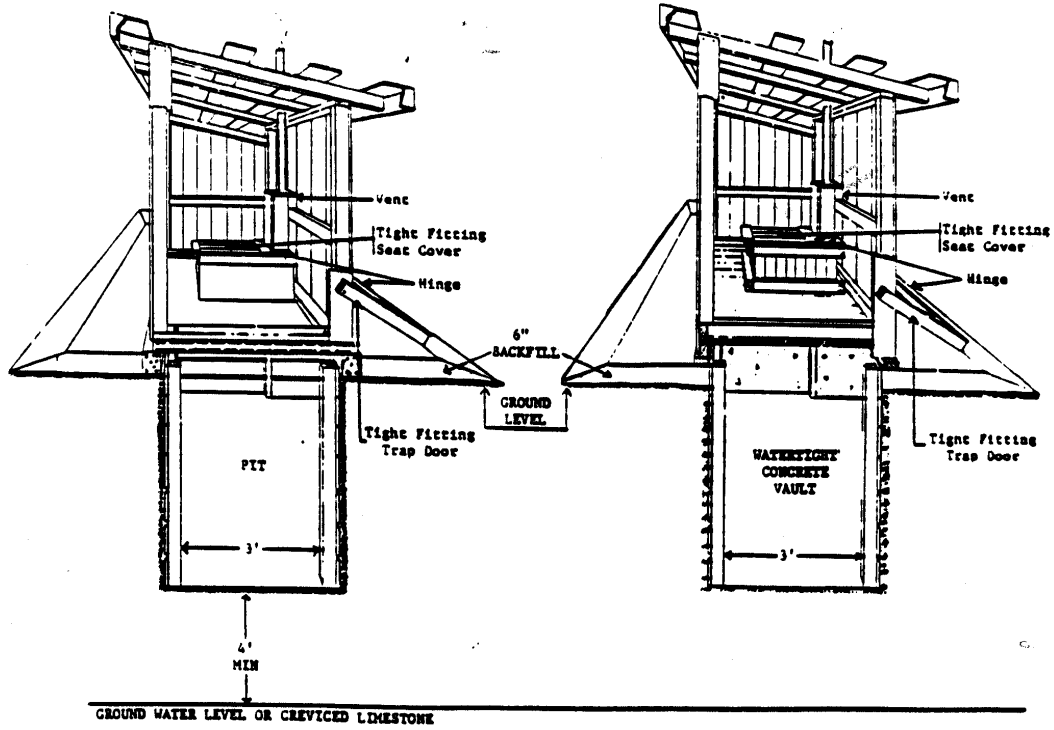

(Source: Amended at 20 Ill. Reg. 2431, effective March 15, 1996)

Section 905.APPENDIX A Illustrations and Exhibits

Section 905.ILLUSTRATION U Septic Privy Distribution System

Section 905.EXHIBIT A Plan View

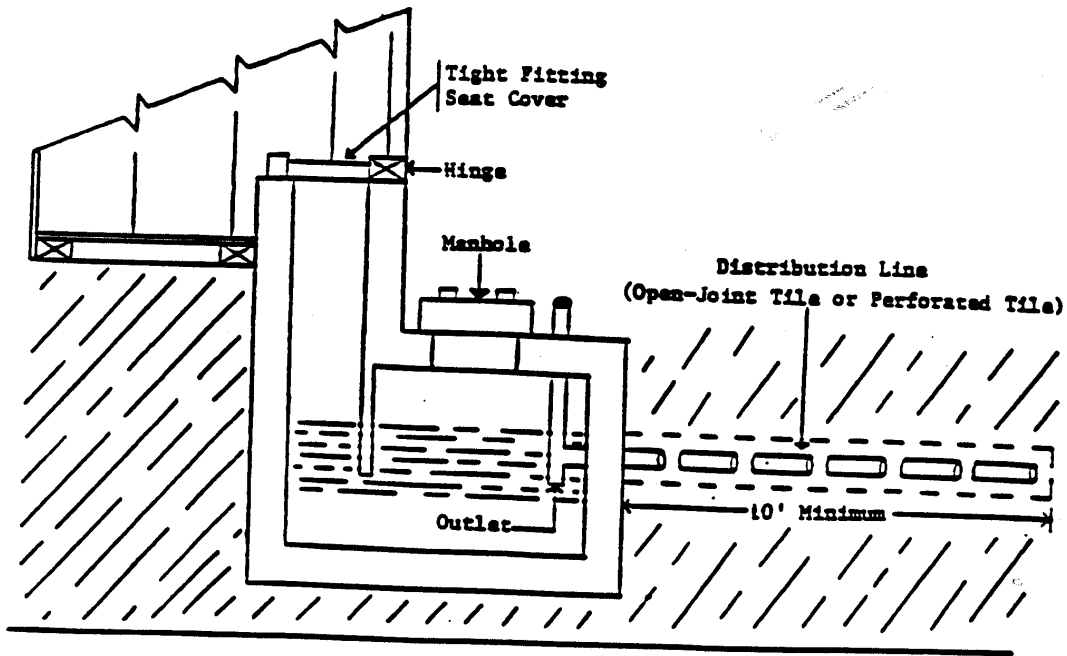

(Source: Amended at 20 Ill. Reg. 2431, effective March 15, 1996)

Section 905.APPENDIX A Illustrations and Exhibits

Section 905.ILLUSTRATION U Septic Privy Distribution System

Section 905.EXHIBIT B Section View

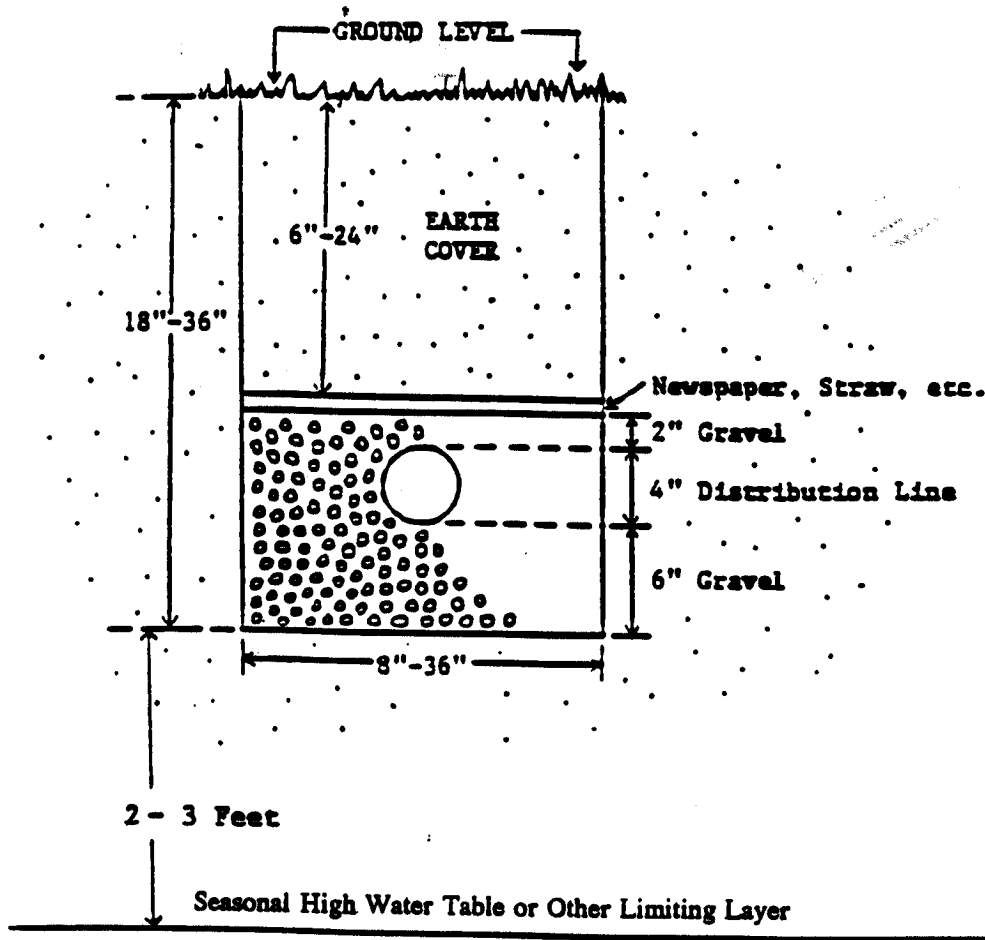

(Source: Amended at 20 Ill. Reg. 2431, effective March 15, 1996)

Section 905.APPENDIX A Illustrations and Exhibits

Section 905.ILLUSTRATION V Sanitary Dump Station

Section 905.EXHIBIT A Section View #1

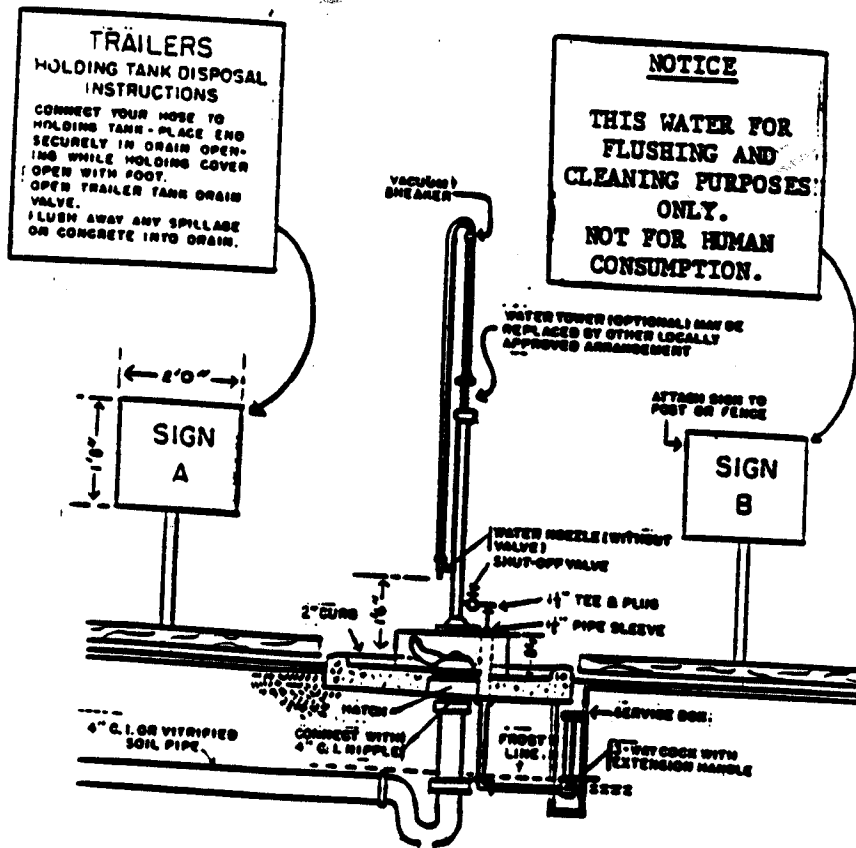

(Source: Amended at 20 Ill. Reg. 2431, effective March 15, 1996)

Section 905.APPENDIX A Illustrations and Exhibits

Section 905.ILLUSTRATION V Sanitary Dump Station

Section 905.EXHIBIT B Plan View

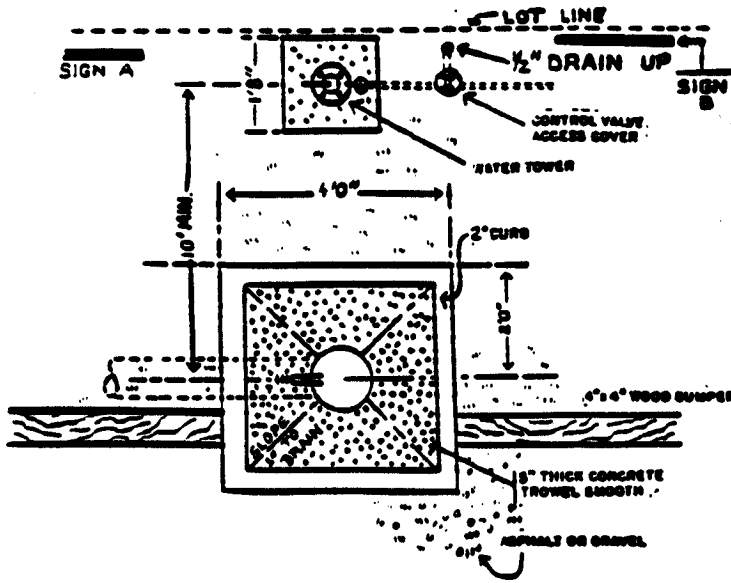

(Source: Amended at 20 Ill. Reg. 2431, effective March 15, 1996)

Section 905.APPENDIX A Illustrations and Exhibits

Section 905.ILLUSTRATION V Sanitary Dump Station

Section 905.EXHIBIT C Section View #2

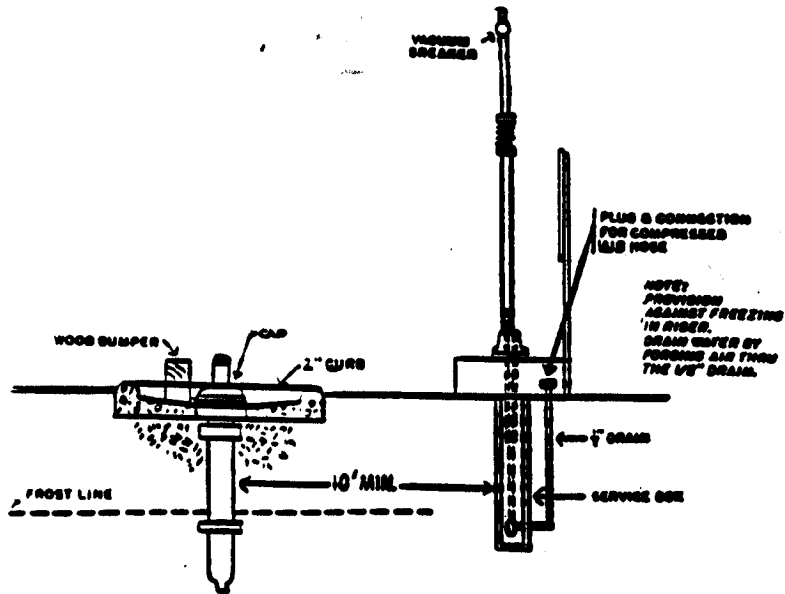

(Source: Amended at 20 Ill. Reg. 2431, effective March 15, 1996)

Section 905.APPENDIX A Illustrations and Exhibits

Section 905.ILLUSTRATION W Swimming Pool Backwash Water Holding Tank

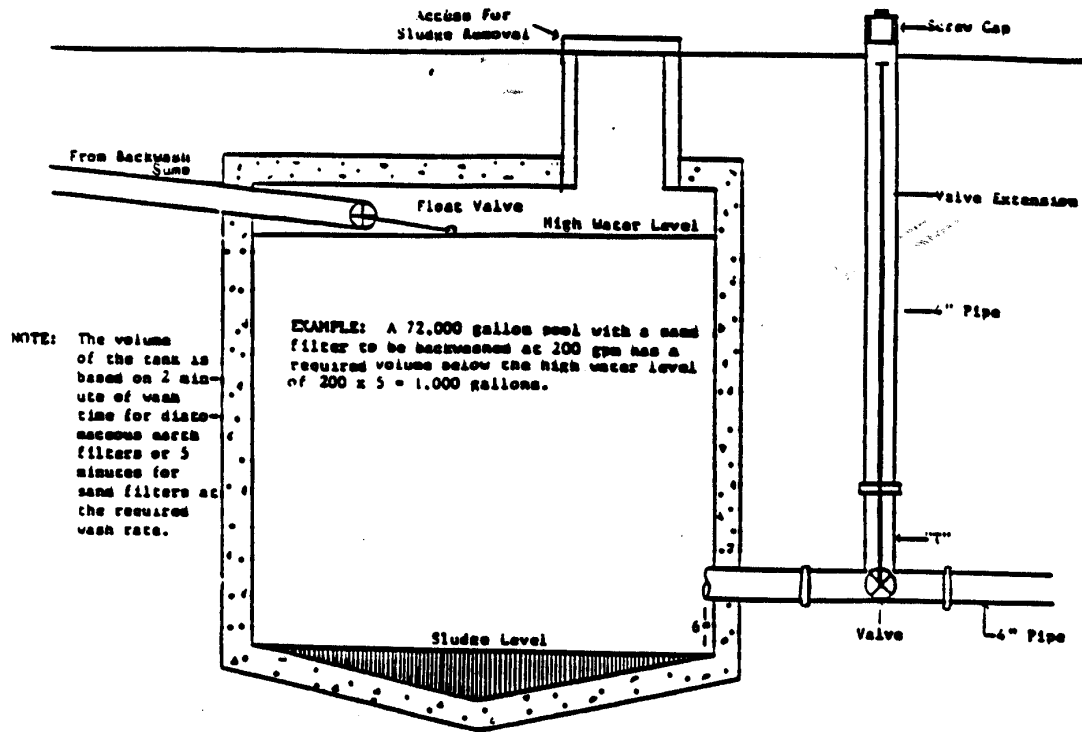

(Source: Amended at 20 Ill. Reg. 2431, effective March 15, 1996)



77 ILLINOIS ADMINISTRATIVE CODE 905  
OCTOBER 2013

**Section 905.APPENDIX A Illustrations and Exhibits**

**Section 905.ILLUSTRATION X Illinois Raised Filter Bed**

**Section 905.EXHIBIT A Sizing Requirements**

U.S./GALS	RESIDENTIAL		NON-RESIDENTIAL	
	BEDS 4 GAL/SQ FT Minimum SQ FT	SUGGESTED BED SIZE Minimum	BEDS 2.5 GALS/SQ FT Minimum SQ FT	SUGGESTED BED SIZE Minimum
300	75 SQ/FT	7'6" X 10'0"	120 SQ/FT	10'0" X 12'0"
450	112.5 SQ/FT	10'0" X 11'3"	180 SQ/FT	12'0" X 15'0"
500	125 SQ/FT	10'0" X 12'6"	200 SQ/FT	12'0" X 17'0"
600	150 SQ/FT	12'0" X 12'6"	240 SQ/FT	15'0" X 16'0"
800	200 SQ/FT	12'0" X 16'8"	320 SQ/FT	16'0" X 20'0"
1,000	250 SQ/FT	12'0" X 21'0"	400 SQ/FT	20'0" X 20'0"
1,100	275 SQ/FT	12'6" X 22'0"	440 SQ/FT	20'0" X 22'0"
1,200	300 SQ/FT	15'0" X 20'0"	480 SQ/FT	20'0" X 24'0"
1,300	325 SQ/FT	15'0" X 22'0"	520 SQ/FT	20'0" X 26'0"
1,400	350 SQ/FT	18'0" X 20'0"	560 SQ/FT	20'0" X 28'0"
1,500	375 SQ/FT	18'0" X 21'0"	600 SQ/FT	20'0" X 30'0"
1,600			640 SQ/FT	2 @ 16'0" X 20'0"
1,700			680 SQ/FT	2 @ 17'0" X 20'0"
1,800			720 SQ/FT	2 @ 18'0" X 20'0"
2,000			800 SQ/FT	2 @ 20'0" X 20'0"
2,100			840 SQ/FT	2 @ 20'0" X 21'0"
2,200			880 SQ/FT	2 @ 20'0" X 22'0"
2,400			960 SQ/FT	2 @ 20'0" X 24'0"
2,500			1,000 SQ/FT	2 @ 20'0" X 25'0"
3,000			1,200 SQ/FT	2 @ 24'0" X 25'0"
12,000			4,800 SQ/FT	8 @ 24'0" X 25'0"

(Source: Old Illustration X repealed at 9 Ill. Reg. 20738, effective January 3, 1986; new Illustration X added at 27 Ill. Reg. 3074, effective February 10, 2003)

Section 905.APPENDIX A Illustrations and Exhibits

Section 905.ILLUSTRATION X Illinois Raised Filter Bed

Section 905.EXHIBIT B Batch Treatment Aeration Tank Design Requirements

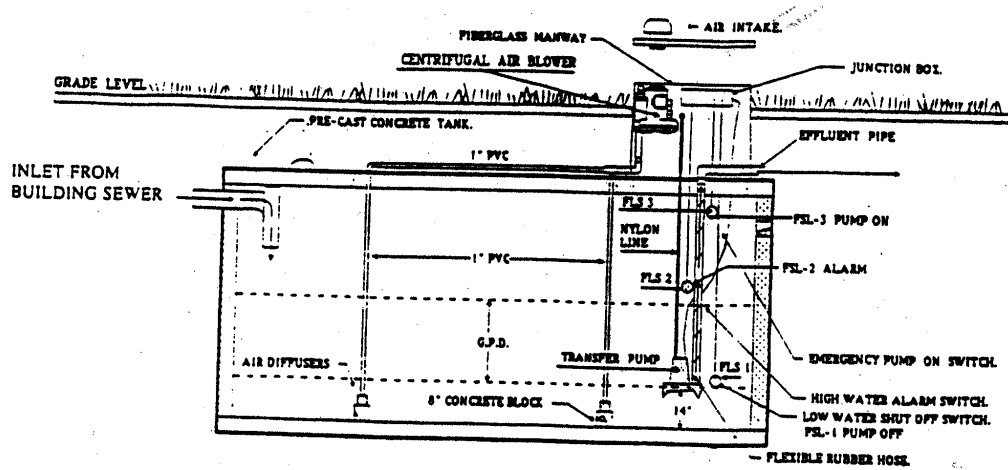

(Source: Added at 27 Ill. Reg. 3074, effective February 10, 2003)

Section 905.APPENDIX A Illustrations and Exhibits

Section 905.ILLUSTRATION X Illinois Raised Filter Bed

Section 905.EXHIBIT C Filter Bed Cross Section (Side View)

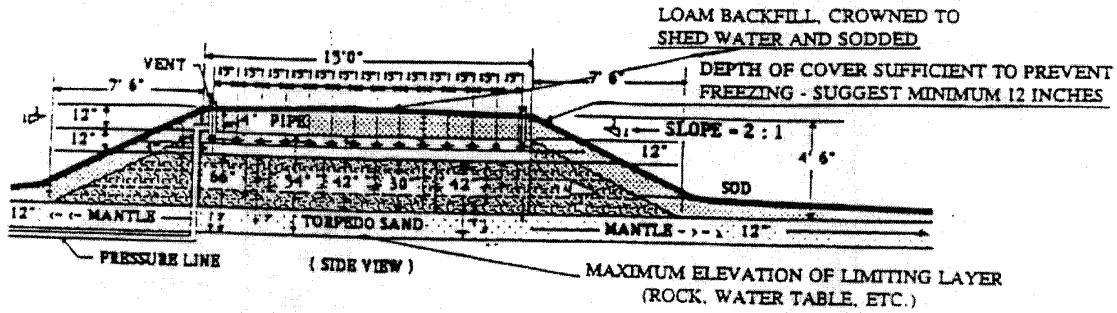

(Source: Added at 27 Ill. Reg. 3074, effective February 10, 2003)

Section 905.APPENDIX A Illustrations and Exhibits

Section 905.ILLUSTRATION X Illinois Raised Filter Bed

Section 905.EXHIBIT D Filter Bed Cross Section (End View)

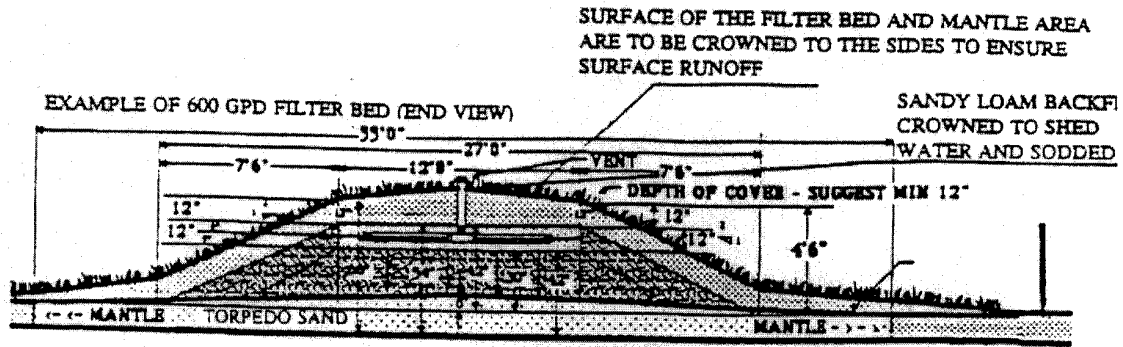

NOTE: CROWNING SHOWN FOR TORPEDO SAND APPLIES TO MANTLE AREA ONLY

(Source: Added at 27 Ill. Reg. 3074, effective February 10, 2003)

**Section 905.APPENDIX A Illustrations and Exhibits**

**Section 905.ILLUSTRATION X Illinois Raised Filter Bed**

**Section 905.EXHIBIT E Sizing Requirements Using Soils Investigation Information**

<b>Design Group</b>	<b>Percolation Rate Equivalent</b>
<b>I</b>	<b>Unsuitable</b>
<b>II</b>	<b>10 minutes/inch</b>
<b>III</b>	<b>15 minutes/inch</b>
<b>IV</b>	<b>20 minutes/inch</b>
<b>V</b>	<b>23 minutes/inch</b>
<b>VI</b>	<b>25 minutes/inch</b>
<b>VII</b>	<b>30 minutes/inch</b>
<b>VIII</b>	<b>35 minutes/inch</b>
<b>IX</b>	<b>40 minutes/inch</b>
<b>X</b>	<b>50 minutes/inch</b>
<b>XI</b>	<b>70 minutes/inch</b>
<b>XII</b>	<b>90 minutes/inch</b>

(Source: Added at 27 Ill. Reg. 3074, effective February 10, 2003)

**Section 905.APPENDIX B Contact Information for the Central and Regional Offices**

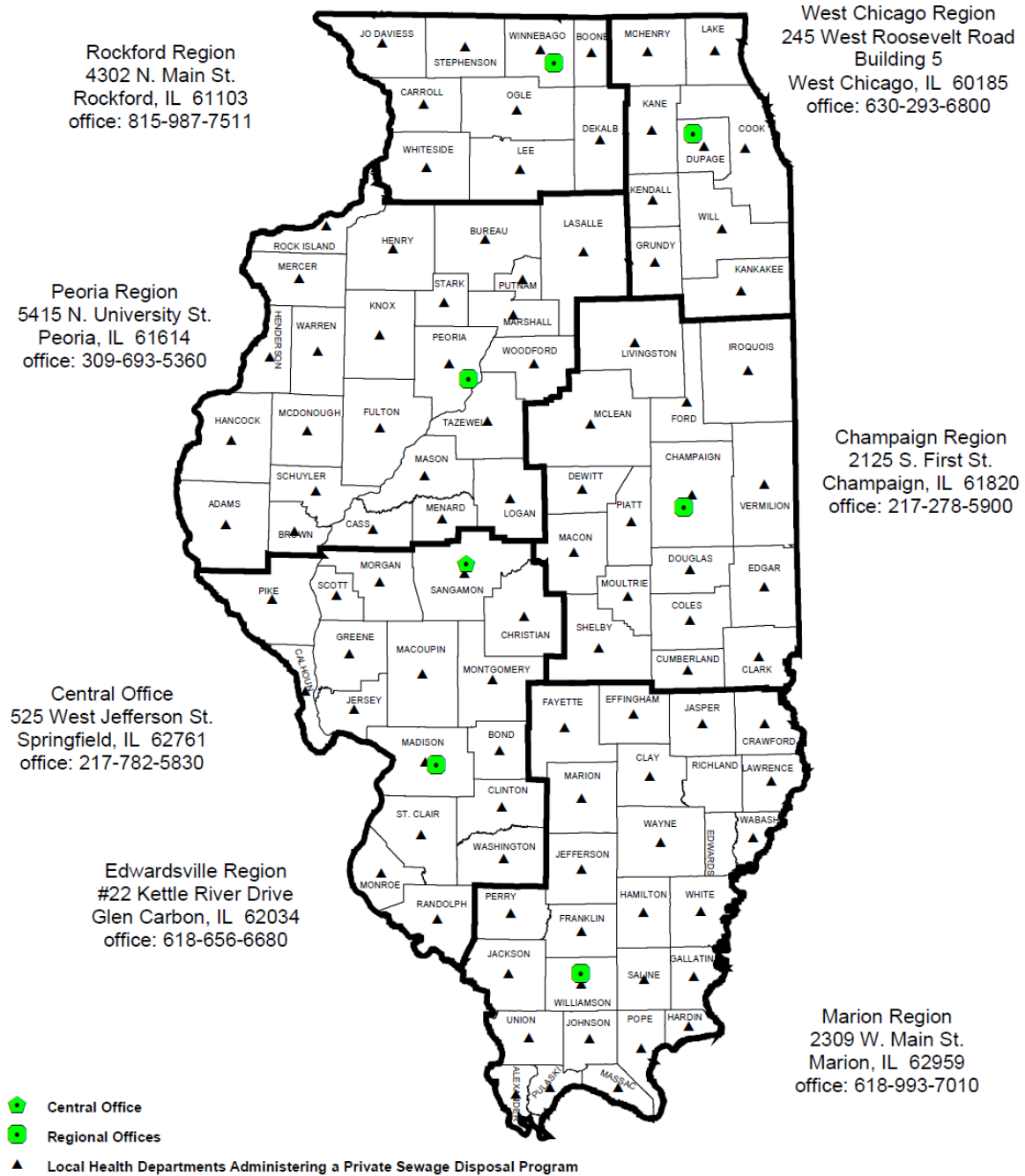

(Source: Amended at 37 Ill. Reg. 14994, effective August 28, 2013)